

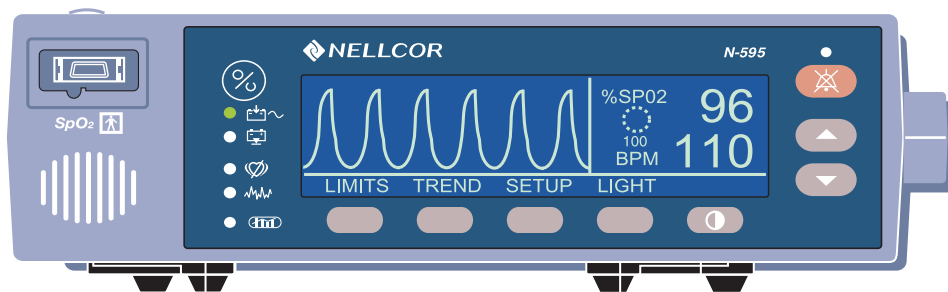

# OXIMAX N-595

Pulse Oximeter  
Operator's Manual



---

**Nellcor Puritan Bennett Inc. is an affiliate of Tyco Healthcare. *Nellcor*, *Oxiband*, *Durasensor*, *OxiCliq*, *Dura-Y*, *MAX-FAST*, and *OxiMAX* are trademarks of Nellcor Puritan Bennett Inc.**

**This ISM device complies with Canadian ICES-001.**

**Cet appareil ISM est conforme à la norme NMB-001 Canada.**

**To obtain information about a warranty, if any, contact Nellcor's Technical Services Department, or your local representative.**

**Purchase of this instrument confers no express or implied license under any Nellcor Puritan Bennett patent to use the instrument with any sensor that is not manufactured or licensed by Nellcor Puritan Bennett.**

**Covered by one or more of the following U.S. Patents and foreign equivalents: 4,621,643; 4,653,498; 4,700,708; 4,770,179; Re. 35,122; 4,802,486; 4,869,254; 4,928,692; 4,934,372; 5,078,136; 5,351,685; 5,368,026; 5,485,847; 5,533,507; 5,662,106; and 5,853,364.**

---

# Contents

---

|                |    |
|----------------|----|
| Contents ..... | i  |
| Figures .....  | vi |
| Tables .....   | vi |

## *Safety Information and Introduction*

|                                  |   |
|----------------------------------|---|
| Safety Information .....         | 1 |
| Warnings .....                   | 1 |
| Cautions .....                   | 2 |
| Introduction .....               | 5 |
| Intended Use for the N-595 ..... | 5 |
| How to Use this Manual .....     | 6 |

## *Using the N-595*

|   |    |
|---|----|
| Description of Controls, Indicators, and Symbols .....  | 7  |
| Identification of Front Panel Buttons and Symbols ..... | 7  |
| Identification of Rear Panel Components .....           | 8  |
| N-595 Symbols .....                                     | 8  |
| Description of Controls .....                           | 9  |
| Description of Displays and Indicators .....            | 10 |
| Description of Audible Indicators .....                 | 14 |
| Setting up the Monitor .....                            | 15 |
| List of Components .....                                | 17 |
| Connecting the N-595 to AC Power .....                  | 17 |
| Connecting an Ox/MAx Sensor to the N-595 .....          | 19 |
| Battery Operation .....                                 | 21 |
| Operating the N-595 on Battery Power .....              | 21 |
| Low Battery Indicator .....                             | 22 |
| Using the Monitor .....                                 | 27 |
| Introduction .....                                      | 27 |

- Turning On the Monitor ..... 29
  - OxIMAX* Sensor Attached ..... 31
  - No *OxIMAX* Sensor Attached ..... 33
- Turning the Backlight On or Off ..... 34
- Adjusting Screen Contrast ..... 34
- Selecting the Pleth View ..... 34
- Selecting the Blip View ..... 35
- Setting the Pulse Beep Volume ..... 36
- Setting the Alarm Volume ..... 36
- Setting the Date and Time ..... 37
- Setting Alarm Silence Duration ..... 38
- Disabling Audible Alarms ..... 39
- Selecting Standby Mode ..... 41
- Adult-Pediatric or Neonatal Settings ..... 42
  - Setting Patient Adult-Pediatric/Neonatal Mode ..... 42
- Alarm Limit Changed Indicator ..... 44
- Setting Alarm Limits ..... 44
- Setting SatSeconds Alarm Limit ..... 46
- Setting Monitor Response Mode ..... 47
- Selecting the Display Language ..... 48
- OxIMAX* Sensor Messages ..... 49
  - OxIMAX* Sensor Adjust Condition Messages ..... 50
  - OxIMAX* Sensor Adjust Messages ..... 51

**Monitor Trend ..... 53**

- Monitor Trend Data ..... 53
  - Trend Data Operation ..... 55
- Selecting the Trend Data Display Scale ..... 55
- Reading the Trend Data Display ..... 57
- Dual Trend Data Display ..... 58
- SpO2 Trend Display ..... 59
- Pulse Rate Trend Display ..... 59
- Histogram Trend Data Display ..... 60
- Pulse Amplitude Trend Data Display ..... 61
- Clearing Trend Information ..... 62

***Sensors and Accessories***

***OxIMAX* Sensor Event Record ..... 65**

- Setting In-Sensor Data Type ..... 66
- OxIMAX* Sensor Type ..... 68
- OxIMAX* Sensor Data Type ..... 68
- OxIMAX* Sensor Event Record Data Available ..... 69

---

|  |           |
|--|-----------|
| <i>OxiMAX</i> Sensor Event Record Not Available .....              | 70        |
| <i>OxiMAX</i> Sensor Event Record Graphical Data .....             | 71        |
| Viewing and Printing <i>OxiMAX</i> Sensor Event History Data ..... | 73        |
| <i>OxiMAX</i> Sensor Tabular Event Data .....                      | 75        |
| Viewing and Printing In-Sensor Tabular Event History Data .....    | 76        |
| <b>Printing .....</b>  | <b>79</b> |
| Printing Monitor Trend Information .....                           | 79        |
| Monitor Trend Data in ASCII Mode .....                             | 81        |
| Trend Data in Graph Mode .....                                     | 82        |
| Real-Time Display/Printout Format .....                            | 83        |
| Column Headings .....  | 85        |
| Data Source .....  | 85        |
| Software Version .....   | 85        |
| Alarm Limits .....   | 86        |
| Monitor Mode .....   | 86        |
| Response Mode .....  | 86        |
| Data Column Headings .....   | 87        |
| Time .....   | 87        |
| Patient Data .....   | 87        |
| Operating Status .....   | 88        |
| <b>Using the Data Port .....</b>                                   | <b>91</b> |
| Overview .....   | 91        |
| Connecting to the Data Port .....                                  | 91        |
| Data Port Pinouts .....  | 92        |
| Data Port Setup .....  | 93        |
| Using the Nurse Call Interface .....                               | 95        |
| Setting Nurse Call RS-232 Polarity .....                           | 96        |
| Setting Nurse Call Relays Normally Open/Closed .....               | 97        |
| Calculating the Analog Voltage Output .....                        | 97        |
| <b><i>OxiMAX</i> Sensors and Accessories .....</b>                 | <b>99</b> |
| <i>OxiMAX</i> Sensor Event Record Data .....                       | 99        |
| Selecting an <i>OxiMAX</i> Sensor .....                            | 99        |
| <i>OxiMAX</i> Sensor Features .....                                | 103       |
| Biocompatibility Testing .....                                     | 103       |
| Optional Accessories .....   | 103       |
| GCX Mounting Plate .....   | 105       |
| GCX Poly-Mount (vertical wall mount with<br>19-inch channel) ..... | 106       |
| GCX Poly-Mount (horizontal wall mount with rail adapter) ..        | 107       |
| GCX Poly-Mount Roll Stand .....                                    | 108       |
| GCX Utility Basket .....   | 109       |

|  |            |
|--|------------|
| Soft-Sided Carrying Case .....                 | 110        |
| <b>Performance Considerations .....</b>        | <b>111</b> |
| Performance Verification .....                 | 111        |
| N-595 Monitor Performance Considerations ..... | 111        |
| Dysfunctional Hemoglobins .....                | 112        |
| Anemia .....                                   | 112        |
| Saturation .....                               | 112        |
| Pulse Rates .....                              | 112        |
| OXIMAX Sensor Performance Considerations ..... | 113        |

### ***Troubleshooting***

|   |            |
|---|------------|
| <b>Troubleshooting .....</b>              | <b>117</b> |
| Error Codes .....                         | 117        |
| Prompts and Error Messages .....          | 119        |
| Corrective Action .....                   | 122        |
| EMI (Electro-magnetic Interference) ..... | 125        |
| Obtaining Technical Assistance .....      | 126        |
| OXIMAX Sensor Message Setup .....         | 127        |
| <b>Maintenance .....</b>                  | <b>129</b> |
| Returning the N-595 .....                 | 129        |
| Service .....                             | 129        |
| Periodic Safety Checks .....              | 130        |
| Cleaning .....                            | 130        |
| <b>Menu Structure .....</b>               | <b>131</b> |
| N-595 Menu Description .....              | 131        |

### ***Technical Information***

|                                |            |
|--------------------------------|------------|
| <b>SatSeconds .....</b>        | <b>135</b> |
| Describing SatSeconds .....    | 135        |
| SatSeconds “Safety Net” .....  | 137        |
| SatSeconds Display .....       | 137        |
| <b>Factory Defaults .....</b>  | <b>139</b> |
| Neonate Default Settings ..... | 139        |
| Adult Default Settings .....   | 140        |

---

|   |     |
|---|-----|
| Principles of Operation .....                 | 143 |
| Oximetry Overview .....                       | 143 |
| Automatic Calibration .....                   | 144 |
| Functional versus Fractional Saturation ..... | 144 |
| Measured versus Calculated Saturation .....   | 145 |
| <i>OxiMAX</i> Technology .....                | 145 |
| Specifications .....                          | 147 |
| Performance .....                             | 147 |
| Electrical .....                              | 148 |
| Environmental Conditions .....                | 149 |
| Physical Characteristics .....                | 151 |
| Compliance .....                              | 152 |
| Manufacturer's Declaration .....              | 155 |
| Index .....                                   | 167 |

## *Figures*

---

|            |  |     |
|------------|--|-----|
| Figure 1:  | Front Panel Buttons and Symbols .....                              | 7   |
| Figure 2:  | Rear Panel Components .....  | 8   |
| Figure 3:  | ASCII Mode Printout .....  | 82  |
| Figure 4:  | Graph Mode Printout .....  | 83  |
| Figure 5:  | Real-Time Printout .....   | 84  |
| Figure 6:  | Data Port Pin Layout .....   | 93  |
| Figure 7:  | GCX Mounting Plate .....   | 105 |
| Figure 8:  | GCX Poly-Mount (vertical wall mount with<br>19-inch channel) ..... | 106 |
| Figure 9:  | GCX Poly-mount (horizontal wall mount with<br>rail adapter) .....  | 107 |
| Figure 10: | GCX Poly-mount Roll Stand .....                                    | 108 |
| Figure 11: | GCX Utility Basket .....   | 109 |
| Figure 12: | Soft-Sided Carrying Case .....                                     | 110 |
| Figure 13: | Alarm Response with SatSeconds .....                               | 136 |
| Figure 14: | Oxyhemoglobin Dissociation Curve .....                             | 145 |



---

# Tables

---

|           |  |     |
|-----------|--|-----|
| Table 1:  | Audible Indicators .....                                 | 14  |
| Table 2:  | Low Battery and Critical Battery .....                   | 23  |
| Table 3:  | Parameter Ranges .....                                   | 27  |
| Table 4:  | Reading Trend Display .....                              | 57  |
| Table 5:  | Data Port Pinouts .....                                  | 92  |
| Table 6:  | Analog Pinouts .....                                     | 97  |
| Table 7:  | Nellcor OXIMAX Sensor Models and<br>Patient Sizes .....  | 101 |
| Table 8:  | OXIMAX Sensor Features .....                             | 103 |
| Table 9:  | Error Codes .....  | 118 |
| Table 10: | Prompt/Error Messages .....                              | 120 |
| Table 11: | Neonate Factory Defaults .....                           | 139 |
| Table 12: | Adult Factory Defaults .....                             | 140 |
| Table 13: | Electromagnetic Emissions .....                          | 155 |
| Table 14: | Electromagnetic Immunity .....                           | 156 |
| Table 15: | Electromagnetic Immunity, RF Portable<br>Equipment ..... | 159 |
| Table 16: | Recommended Separation Distances .....                   | 161 |
| Table 17: | Cables .....   | 162 |



# Safety Information

---

---

## Warnings



Warnings are identified by the WARNING symbol shown above.

Warnings alert the user to potential serious outcomes (death, injury, or adverse events) to the patient or user.



---

**WARNING: The sensor extrapolates from the date and time provided by the N-595 when recording the sensor event record to the sensor. The accuracy of the date/time is the responsibility of the N-595. It is recommended that the N-595 user set the time/date to the correct value before a sensor event record-enabled sensor is connected, and that this date/time not be changed while the sensor remains connected. Since a sensor with sensor event record data can be transported from one monitor to another, having discrepancies in the date/time between monitors and the sensor event record data will affect the order the sensor event record data appears. To eliminate this possible problem, all monitors within an institution should be set to the same time.**

---



---

**WARNING: Explosion hazard. Do not use the N-595 pulse oximeter in the presence of flammable anesthetics or gases.**

---



---

**WARNING: Chemicals from a broken LCD display panel are toxic when ingested. Use caution when handling a pulse oximeter with a broken display panel.**

---



**WARNING:** Pulse oximetry readings and pulse signals can be affected by certain environmental conditions, *OxIMAX* sensor application errors, and certain patient conditions. See the appropriate sections of this manual for specific safety information.

---



**WARNING:** The use of accessories, sensors, and cables other than those specified may result in increased emission and/or decreased immunity and inaccurate readings of the N-595 pulse oximeter.

---



**WARNING:** Failure to cover the *OxIMAX* sensor site with opaque material in high ambient light conditions may result in inaccurate measurements.

---

---

## Cautions



Cautions are identified by the CAUTION symbol shown above.

Cautions alert the user to exercise care necessary for the safe and effective use of the N-595 pulse oximeter.



**Caution:** When connecting the N-595 to any instrument, verify proper operation before clinical use. Both the N-595 and the instrument connected to it must be connected to a grounded outlet. Accessory equipment connected to the pulse oximeter's data interface must be certified according to IEC Standard 950 for data-processing equipment or IEC Standard 60601-1 for electromedical equipment. All combinations of equipment must be in compliance with IEC Standard 60601-1-1 systems requirements. Anyone who connects additional equipment to the signal input port or signal output port (N-595 data port connector) configures a medical system and is therefore responsible for ensuring that the system complies with the requirements of system standard IEC Standard 60601-1-1 and the electromagnetic compatibility system standard IEC Standard 60601-1-2. The N-595 accuracy may degrade if it is connected to secondary I/O devices when the instrument is not connected to earth reference.



**Caution:** Federal law (U.S.A.) restricts this device to sale by or on the order of a physician.



**Caution:** Dispose of battery in accordance with local requirements and regulations.



# Introduction

---



**WARNING: The N-595 is intended only as an adjunct in patient assessment. It must be used in conjunction with clinical signs and symptoms.**

---

---

## Intended Use for the N-595

The N-595 pulse oximeter is indicated for the continuous non-invasive monitoring of functional oxygen saturation of arterial hemoglobin (SpO<sub>2</sub>) and pulse rate. The N-595 is intended for use with neonatal, pediatric, and adult patients during both no motion and motion conditions and for patients who are well or poorly perfused, in hospitals, hospital-type facilities, intra-hospital transport, and home environments. For prescription use only.

**Note:** Hospital use typically covers such areas as general care floors, operating rooms, special procedure areas, intensive and critical care areas, within the hospital plus hospital-type facilities. Hospital-type facilities include physician office based facilities, sleep labs, skilled nursing facilities, surgicenters, and sub-acute centers.

Intra-hospital transport includes transport of a patient within the hospital or hospital-type facility.

Home Care use is defined as managed/used by a lay person (parent or other similar non-critical caregiver) in the home environment.

Use with any particular patient requires the selection of an appropriate oxygen *OxiMAX* sensors as described in this Operator's Manual.

Motion performance claims are applicable to models MAX-A, MAX-AL, MAX-P, MAX-N, and MAX-I Nellcor *OxiMAX*<sup>™</sup> oximetry sensors.

---

## How to Use this Manual

All users should read this manual thoroughly. More experienced users of the N-595 will be able to go to the topics for the information they require.

The current copy of this manual is available on the internet at:

[http://www.mallinckrodt.com/respiratory/resp/Serv\\_Supp/ProductManuals.html](http://www.mallinckrodt.com/respiratory/resp/Serv_Supp/ProductManuals.html)



# Description of Controls, Indicators, and Symbols

## Identification of Front Panel Buttons and Symbols

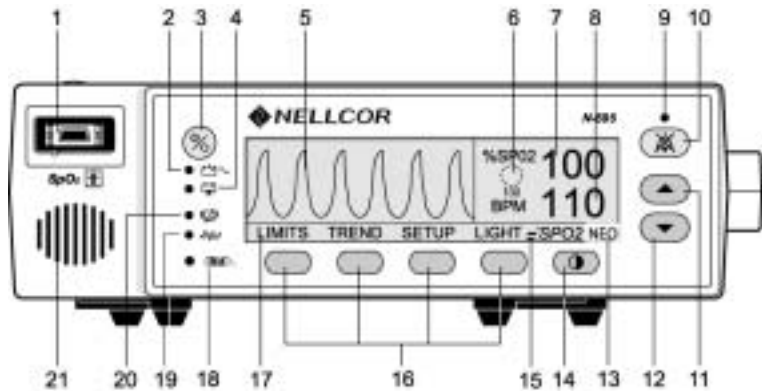

|  |   |
|--|---|
| 1. SpO2 <i>OxiMAX</i> Sensor Port, page 19 | 12. ADJUST DOWN Button, page 10           |
| 2. AC Power Indicator, page 12             | 13. Neonate Mode Indicator, page 13       |
| 3. ON/STANDBY Button, page 9               | 14. CONTRAST Button, page 10              |
| 4. Low Battery Indicator, page 12          | 15. Fast Response Mode Indicator, page 13 |
| 5. Waveform Display, page 10               | 16. Softkeys, page 10                     |
| 6. <i>SatSeconds</i> ™ Indicator, page 13  | 17. Menu Bar, page 10                     |
| 7. %SpO2 Display, page 12                  | 18. Data In Sensor Indicator, page 13     |
| 8. Pulse Rate Display, page 12             | 19. Motion Indicator, page 12             |
| 9. Alarm Silence Indicator, page 12        | 20. Pulse Search Indicator, page 13       |
| 10. ALARM SILENCE Button, page 9           | 21. Speaker                               |
| 11. ADJUST UP Button, page 10              |   |

**Figure 1: Front Panel Buttons and Symbols**

## Identification of Rear Panel Components

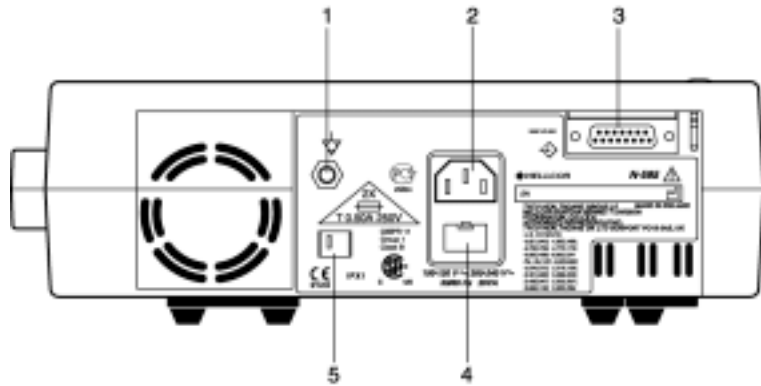

|                                    |  |
|------------------------------------|--|
| 1. Equipotential Terminal (Ground) | 4. Fuse Holder                             |
| 2. AC Power Connector, page 17     | 5. Supply Voltage Selector Switch, page 17 |
| 3. Data Port Connector, page 91    |  |

**Figure 2: Rear Panel Components**

## N-595 Symbols

The symbols that are located on the rear panel of the N-595 are as follows:

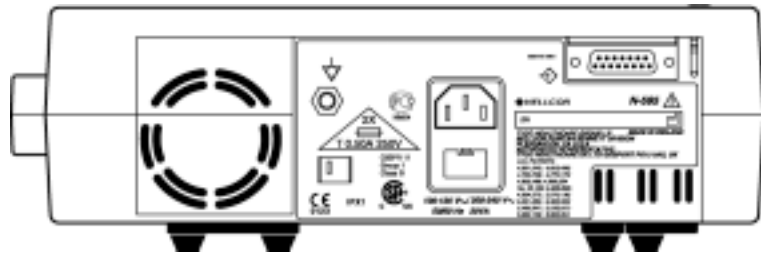



See Instructions for Use



Fuse Replacement

 Equipotential Terminal (ground)

 Date of Manufacture

 Data Interface

There is one symbol located on the front panel of the N-595.

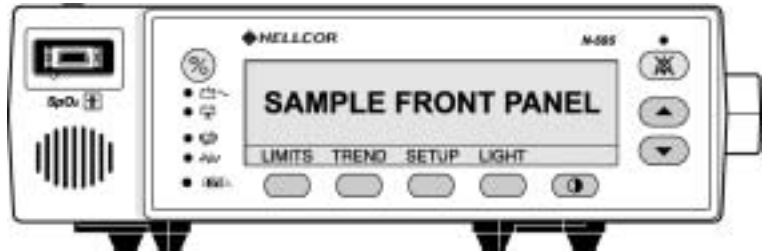

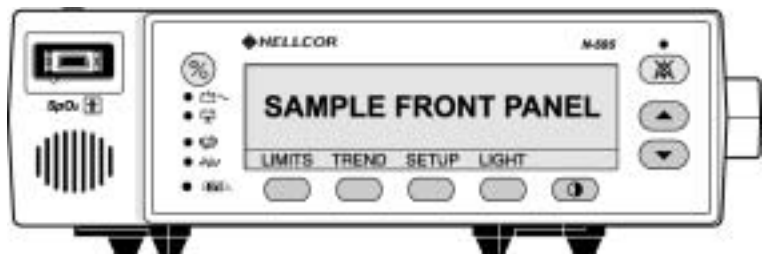

 Type BF Applied Part - Not defibrillator proof.

## Description of Controls



**Note:** A button press, except the ON/STANDBY button, should result in either a valid or an invalid key tone (refer to Table 1 on page 14). If the key pressed fails to emit a tone, contact qualified service personnel.

 The ON/STANDBY button. Used to turn the N-595 monitor on or off.

 The ALARM SILENCE button. Used to silence current alarms for the alarm silence duration period. When an alarm has been silenced, pressing the button again reactivates, or “unsilences” the alarm. It is also used to view and adjust alarm silence duration and alarm volume.

The ALARM SILENCE button clears “SENSOR OFF,” “LOW BATTERY,” and “SENSOR DISCONNECT” messages from the display.



The ADJUST UP button. Used to increase variable parameters of the monitor.



The ADJUST DOWN button. Used to decrease variable parameters in the monitor.



The CONTRAST button. Used in conjunction with the ADJUST UP and ADJUST DOWN buttons to lighten or darken the display screen.



The softkey buttons have multiple uses depending on the legend displayed above the button.

## Description of Displays and Indicators

The type of display is user selectable. Refer to *Selecting the Pleth View* on page 34.

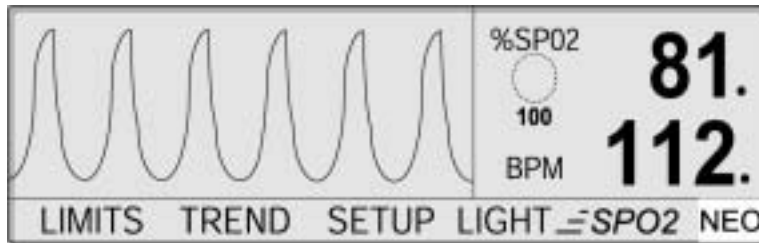

The pleth display includes a “wiper bar” plethysmographic waveform, menu bar, and current measured %SpO<sub>2</sub> and pulse rate. If *SatSeconds* are enabled, the pleth display includes the *SatSeconds* indicator and *SatSeconds* setting. A decimal point after the %SpO<sub>2</sub> or

pulse rate indicate that the respective limits have been changed from the power on defaults (*Monitor Trend Data* on page 53).

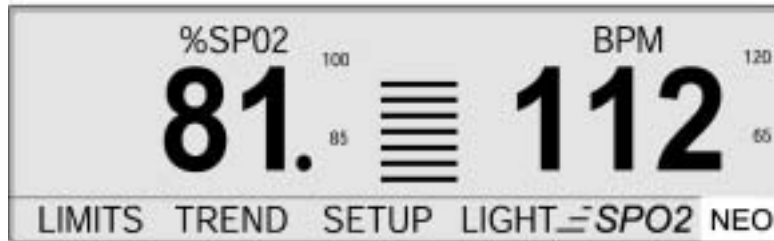

The blip display includes a pulse amplitude blip bar, current measured %SpO<sub>2</sub> and pulse rate, and current upper and lower %SpO<sub>2</sub> and pulse rate limits. If *SatSeconds* are enabled, the blip display includes the *SatSeconds* indicator and *SatSeconds* setting. Decimal points after the %SpO<sub>2</sub> or pulse rate indicate that the respective limits have been changed from the power-on defaults.

There are various matrixes within the OxiMAX algorithm. Some of these, are used to assess the severity of conditions presented to the N-595 in measuring SpO<sub>2</sub> and pulse rate on a patient. These individual matrices or combinations of these matrices are used to drive the LED indicators on the N-595 front panel.

The *OxiMax* algorithm automatically extends the amount of data required for measuring SpO<sub>2</sub> and pulse rate depending on the measurement conditions. During normal measurement conditions the averaging time is 6-7 seconds. During challenging measurement conditions which could be caused by low perfusion, motion, external interference like ambient light, or a combination of these, the OXIMAX algorithm automatically extends the amount of data required beyond 7 seconds. If the resulting dynamic averaging time exceeds 20 seconds, the pulse search indicator is lit solid and SpO<sub>2</sub> and Pulse Rate will continue to be updated every second. As these conditions become even more challenging, the amount of data required continues to extend. If the dynamic averaging time reaches 40 seconds, the pulse search indicator begins flashing, the SpO<sub>2</sub> and pulse rate displays flash zeros indicating a loss-of-pulse condition.



**WARNING: Failure to cover the *OxiMAX* sensor site with opaque material in high ambient light conditions may result in inaccurate measurements.**

**%SpO2 81**

The %SpO2 Display. Shows the hemoglobin oxygen saturation level. The display value flashes zeros during loss-of-pulse alarms and flashes the SpO2 value when the SpO2 is outside the alarm limits. During Pulse Search, the monitor continues to update the display. If alarm limits have been changed from their power-on defaults, a decimal point (.) is displayed after the SpO2 value (81.).



The Pulse Amplitude Indicator (blip bar). Indicates pulse beat and shows the relative pulse amplitude. As the detected pulse becomes stronger, more bars light with each pulse. This indicator is available only in the blip view.

**BPM 112**

The Pulse Rate Display. Shows the pulse rate in beats per minute. It flashes during loss-of-pulse alarms and when the pulse rate is outside of the alarm limits. During Pulse Search, the monitor continues to update the display. Pulse rates outside of the pulse rate range (20 to 250 bpm) are displayed as the closest value within the range. If alarm limits have been changed from their power-on defaults, a decimal point (.) is displayed after the BPM value (112.).



The AC Power Indicator. Lights continuously when the N-595 is connected to AC power. It also indicates that the battery is charging. It is off when the monitor is being powered by internal battery.



The Low Battery Indicator. Lights continuously when 15 or fewer minutes of battery capacity remain. Flashes when the battery capacity reaches critical condition.





The Alarm Silence Indicator. Lights continuously when an audible alarm has been silenced. It flashes when the alarm silence duration has been set to Off.





The Motion Indicator. The motion indicator is lit whenever the *OxiMAX* algorithm detects the presence of artifacts<sup>1</sup> independent of its severity or the impact on the SpO2 or pulse rate values. When the

motion indicator and the pulse search indicator are simultaneously lit, it is an indication that the artifact is significant and/or has been persistent.

- 

The Pulse Search Indicator. Lights continuously prior to initial acquisition of a pulse signal and during prolonged and challenging monitoring conditions. The pulse search indicator flashes during a loss-of-pulse signal.
- 

The Data In-Sensor Indicator. Lights to indicate that the attached *OxiMAX* sensor contains a patient sensor event record. The sensor event record information may be viewed or printed.
- 

The *SatSeconds* Indicator. Fills in clockwise as the *SatSeconds* alarm management system detects a %SpO<sub>2</sub> reading outside of the limit setting. Empties in counterclockwise direction when %SpO<sub>2</sub> reading is within limits. When the indicator is full, a medium priority alarm will sound.
- 

The Fast Response Mode Indicator. The response mode setting dictates the response time (2 to 4 seconds in fast mode and 4 to 7 seconds in normal mode) applied by the *OxiMAX* algorithm in its calculation of SpO<sub>2</sub>. The *OxiMAX* algorithm's calculation of pulse rate is unaffected by the response mode setting. The trending interval (2-seconds or 4-seconds) is updated automatically by the monitor to roughly correspond with the SpO<sub>2</sub> calculation response time.
- 

The Neonate Alarm Limits Indicator. This symbol is displayed when the alarm limits are set to neonate. No symbol is displayed when the monitor is set to adult limits.

<sup>1</sup> Artifacts are events contained in the in-sensor data.

## Description of Audible Indicators

Table 1 identifies the audible indicators of the N-595 indicators.

**Table 1: Audible Indicators**

| Function                | Description  |
|-------------------------|--|
| Alarm Silence Reminder  | Three beeps that sound approximately every 3 minutes when alarms are silenced with the alarm silence duration set to Off and the alarm silence reminder function is enabled. |
| Confirmation Tone       | Three beeps sound to indicate that default settings have been saved or reset to factory defaults or trend data has been deleted.   |
| Invalid Button Press    | A short, low-pitched tone indicating that a button has been pressed that is not appropriate for the current state of the monitor.  |
| Valid Button Press      | A short, medium-pitched tone indicating that an appropriate button has been pressed.   |
| High Priority Alarm     | A high-pitched, fast-pulsing tone indicating loss-of-pulse.  |
| Medium Priority Alarm   | A medium-pitched, pulsing tone indicating an SpO2 or pulse rate limit violation.   |
| Low Priority Alarm      | A low-pitched, slow-pulsing tone indicating an <i>OxiMAX</i> sensor disconnect, low battery, or monitor failure.   |
| Power-On Self-Test Pass | A 1-second tone indicating that the N-595 has been turned on and has successfully completed the power-on self-test.  |
| Pulse Beep              | A single beep sounds for each detected pulse. The pitch of the pulse beep signal changes with a point-by-point rise or fall in the saturation level.                         |
| Volume Setting Tone     | A continuous tone that is used when adjusting the alarm volume.  |



## Setting up the Monitor

---



**WARNING:** To ensure patient safety, do not place the pulse oximeter in any position that might cause it to fall on the patient.

---



**WARNING:** As with all medical equipment, carefully route patient cabling to reduce the possibility of patient entanglement or strangulation.

---



**WARNING:** Ensure that the speaker is clear of any obstruction. Failure to do so could result in an inaudible alarm tone.

---



**WARNING:** Disconnect the N-595 and Nellcor *OxiMAX* sensor from the patient during magnetic resonance imaging (MRI) scanning. Induced current could potentially cause burns.

---



**WARNING:** To ensure accurate performance and prevent device failure, do not subject the N-595 to extreme moisture, such as direct exposure to rain. Such exposure may cause inaccurate performance or device failure.

---



**WARNING:** Do not use an N-595 pulse oximeter, *OxiMAX* sensor, cables, or connectors that appear damaged.

---



**WARNING:** Do not lift the pulse oximeter by the pulse oximetry cable or power cord because the cable or cord could disconnect from the pulse oximeter, causing the pulse oximeter to drop on the patient.

---



---

**WARNING:** The N-595 is not defibrillator-proof. However, it may remain attached to the patient during defibrillation or while an electrosurgical unit is in use, but the readings may be inaccurate during the defibrillation and shortly thereafter.

---



---

**WARNING:** In the USA, do not connect the pulse oximeter to an electrical outlet controlled by a wall switch, because the pulse oximeter may be accidentally turned off.

---



---

**WARNING:** Use only the Nellcor pulse oximetry cable DOC-10 with the N-595 pulse oximeter. Use of another pulse oximetry cable will have an adverse effect on performance. Do not attach any cable that is intended for computer use to the *OxiMAX* sensor port. Do not connect any device other than a Nellcor-approved *OxiMAX* sensor to the *OxiMAX* sensor connector.

---



---

**WARNING:** The N-595 should not be used adjacent to or stacked with other equipment. If adjacent or stacked use is necessary, the N-595 should be observed to verify normal operation in the configuration it is to be used.

---

## List of Components

| Quantity | Item  |
|----------|---|
| 1        | N-595 Pulse Oximeter  |
| 1        | Nellcor <i>OxiMAX</i> Sensor or Assortment Pack                             |
| 1        | DOC-10 Pulse Oximetry Cable   |
| 1        | N-595 Operator's Manual (applicable to country of sale) and/or Compact Disk |
| 1        | Power Cord (applicable to country of sale)                                  |
| 2        | Fuses, 0.5 A, 250 volts, slow-blow, IEC (5 x 20 mm)                         |
| 1        | Sensor Accuracy Grid  |
| 1        | Quick Guide   |

## Connecting the N-595 to AC Power



**WARNING:** In the USA, do not connect the pulse oximeter to an electrical outlet controlled by a wall switch, because the pulse oximeter may be accidentally turned off.



**Caution:** The **SUPPLY VOLTAGE SELECTOR** switch must be set to the correct voltage (115 or 230) to avoid equipment damage and ensure battery charging.



**Caution: Use only the hospital-grade power cord provided by Nellcor.**

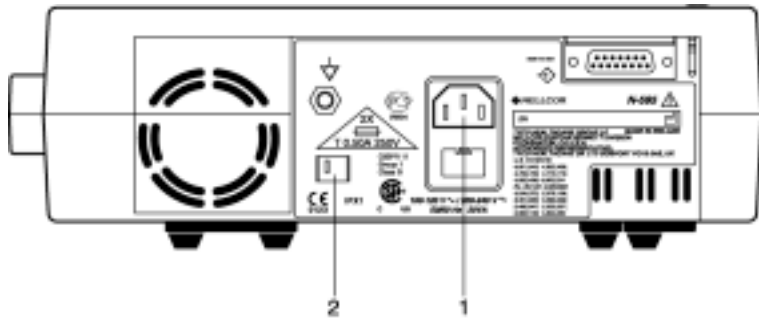

1. Power Connector    2. Supply Voltage Selector

1. Set the SUPPLY VOLTAGE SELECTOR (2) switch to the applicable voltage.
2. Plug the female connector end of the power cord into the N-595 POWER CONNECTOR (1) on the rear of the monitor.
3. Plug the male connector of the power cord into a properly grounded AC outlet.
-  4. Verify that the monitor's AC POWER INDICATOR is lit.

**Note:** If the AC POWER INDICATOR is not lit, check:

- the power cord
- the SUPPLY VOLTAGE SELECTOR switch
- the user-accessible fuses
- the AC power outlet

## Connecting an *OxiMAX* Sensor to the N-595

The *OxiMAX* sensor type is displayed at the bottom of the display when an *OxiMAX* sensor is connected to the N-595 or when the N-595 completes POST with an *OxiMAX* sensor attached.



**Caution:** Use only Nellcor-approved *OxiMAX* sensors and pulse oximetry cables.

**Note:** Physiological conditions, medical procedures, or external agents that may interfere with the monitor's ability to detect and display measurements include dysfunctional hemoglobin, arterial dyes, low perfusion, dark pigment, and externally applied coloring agents, such as nail polish, dye, or pigmented cream.

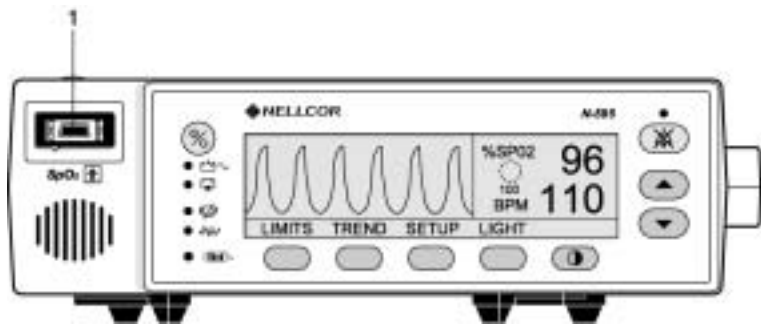

### 1. SpO2 *OxiMAX* Sensor Port

1. Connect a DOC-10 pulse oximetry cable to the SpO2 *OxiMAX* sensor port (1) of the monitor.
2. Connect a Nellcor *OxiMAX* SpO2 sensor to the other end of the DOC-10 pulse oximetry cable.



# Battery Operation

---



**WARNING: Dispose of battery in accordance with local requirements and regulations.**

---

---

## Operating the N-595 on Battery Power

The N-595 monitor has an internal battery that can be used to power the monitor during transport or when AC power is not available. A new, fully charged battery will provide at least 2 hours of monitoring time under the following conditions:

- No audible alarms sound
- No analog or serial output devices are attached to the N-595

The monitor cannot operate with a fully discharged battery. Before attempting to turn on an N-595 monitor whose battery charge has been completely depleted, first plug the monitor into an AC outlet to allow the battery to charge for a few minutes. The monitor may then be powered on.

To charge a low or dead battery, connect the monitor to AC power. A full charge of a dead battery takes 14 hours while the monitor is turned off. A full charge of a dead battery takes 18 hours while the monitor is in operation (monitoring a patient).

When all of the following conditions are present for 15 minutes, the N-595 will automatically shut down:

- Monitor is running on battery power
- No buttons have been pressed

- No pulse has been detected (for example, when a patient is not connected to the *OxiMAX* sensor or the *OxiMAX* sensor is disconnected from the monitor)
- No alarms are present (other than low battery or a non-correctable error)

**Note:** Whenever the monitor is connected to AC power, the battery is being charged. Therefore, it is recommended that the monitor remain connected to AC power when not in use. This will ensure a fully charged battery whenever it is needed.

---

### Low Battery Indicator

The Low Battery Indicator lights and a low priority alarm begins to sound when approximately 15 minutes of monitoring time is available on the existing battery charge. Refer to Table 2 for a description of the low and critical battery conditions.

If the monitor is not on AC power, a low battery audible alarm can be canceled by pressing the ALARM SILENCE button. The low battery indicator and display screen message will continue to be displayed. Plugging the monitor into AC power will silence the audible alarm, but the low battery indicator will stay lit as long as the battery is in the low voltage condition. After the 15-minute period of low battery condition, a high priority alarm will sound for about 10 seconds before the monitor shuts off.

If the monitor backlight is turned off during a low battery condition, the backlight cannot be turned back on.

It is recommended that qualified service personnel replace the internal battery every 24 months. Replaced batteries should be disposed of in accordance with local ordinances.





**Caution:** If the N-595 pulse oximeter is to be stored for a period of 3 months or longer, notify service personnel to remove the battery from the pulse oximeter prior to storage. Recharge the battery when the battery has not been charged for 2 or more months.



**Caution:** The pulse oximeter default settings will return to factory default setting if the battery becomes fully discharged or is replaced. Qualified service personnel will have to reset the institutional defaults, following the instructions in the service manual.

**Note:** If the AC voltage selector switch on the monitor rear panel does not match your AC voltage source, the monitor may run on battery power, even though it is plugged into AC power, which will eventually result in a low priority alarm and a lighted low battery indicator. Ensure that the switch setting matches your AC voltage.

**Note:** As the battery is used and recharged over a period of time, the amount of time between the onset of the low battery alarm and the instrument shut-off may become shorter.

**Table 2: Low Battery and Critical Battery**

| State | Critical Battery | Low Battery | AC  | Operation  |
|-------|------------------|-------------|-----|--|
| 1     | No               | No          | Yes | SpO2- normal<br>AC/Battery charge LED-on<br>LOW BATTERY LED-off<br>LOW BATTERY message-off<br>Audible alarm-off<br>Error code-none<br>Effect of ALARM SILENCE key-normal<br>Shutdown-N/A |

**Table 2: Low Battery and Critical Battery**

| State | Critical Battery | Low Battery | AC | Operation   |
|-------|------------------|-------------|----|---|
| 2     | No               | No          | No | <p>SpO2-normal</p> <p>AC/Battery charge LED-off</p> <p>LOW BATTERY LED-off</p> <p>LOW BATTERY message-off</p> <p>Audible alarm-off</p> <p>Error code-none</p> <p>Effect of ALARM SILENCE key-normal</p> <p>Shutdown- N/A</p>  |
| 3     | No               | Yes         | No | <p>SpO2-normal</p> <p>AC/Battery charge LED-off</p> <p>LOW BATTERY LED-on</p> <p>LOW BATTERY message-on</p> <p>Audible alarm-low priority</p> <p>Error code-logged</p> <p>Effect of ALARM SILENCE key-First press silences audio alarm, second press cancels LOW BATTERY message (LED) stays on until Low Battery Condition is corrected.</p> <p>Shutdown-N/A</p> |

**Table 2: Low Battery and Critical Battery**

| State | Critical Battery | Low Battery | AC  | Operation   |
|-------|------------------|-------------|-----|---|
| 4     | No               | Yes         | Yes | <p>SpO2-normal</p> <p>AC/Battery charge LED-on</p> <p>LOW BATTERY LED-on</p> <p>LOW BATTERY message-off</p> <p>Audible alarm-off</p> <p>Error code-logged</p> <p>Effect of ALARM SILENCE key-N/A (LED stays on)</p> <p>Shutdown-N/A</p> <p><b>Note:</b> Connecting AC functions the same as ALARM SILENCE key in state 3.</p> |
| 5     | Not used         |             |     |   |
| 6     | Yes              | Yes         | No  | <p>SpO2-not displayed</p> <p>AC/Battery charge LED-off</p> <p>LOW BATTERY LED-on (flashing)</p> <p>LOW BATTERY message-on</p> <p>Audible alarm-high priority</p> <p>Error code-displayed and logged</p> <p>Effect of ALARM SILENCE key-none</p> <p>Shutdown-after 10 seconds</p>  |

Using the N-595

**Table 2: Low Battery and Critical Battery**

| <b>State</b> | <b>Critical Battery</b> | <b>Low Battery</b> | <b>AC</b> | <b>Operation</b>  |
|--------------|-------------------------|--------------------|-----------|---|
| 7            | Yes                     | Yes                | Yes       | SpO2-not displayed<br><br>AC/Battery charge LED-on<br><br>LOW BATTERY LED-on (flashing)<br><br>LOW BATTERY message-on<br><br>Audible alarm-high priority<br><br>Error code-displayed and logged<br><br>Effect of ALARM SILENCE key-N/A<br><br>Shutdown-after 10 seconds |

Using the N-595

# Using the Monitor

## Introduction

The parameters of the N-595 monitor are preset to factory default settings. See *Factory Defaults* on page 139. The factory default parameters may be changed to institutional default parameters by following the procedures in the N-595 service manual.

Table 3 lists the parameters, ranges available, and the factory default setting. The parameters may be set on an individual basis, by the clinician, and these settings will remain in effect until the N-595 is turned off.

**Table 3: Parameter Ranges**

| Parameter                    | Ranges/<br>Selections               | Factory Adult<br>Defaults | Factory<br>Neonate<br>Defaults |
|------------------------------|-------------------------------------|---------------------------|--------------------------------|
| %SpO2 Upper Alarm Limit      | Lower Alarm Limit plus 1 to 100%    | 100%                      | 95%                            |
| %SpO2 Lower Alarm Limit      | 20% to Upper Alarm Limit minus 1    | 85%                       | 80%                            |
| Pulse Rate Upper Alarm Limit | Lower Alarm Limit plus 1 to 250 bpm | 170 bpm                   | 190 bpm                        |
| Pulse Rate Lower Alarm Limit | 30 bpm to Upper Alarm Limit minus 1 | 40 bpm                    | 90 bpm                         |
| Alarm Silence Duration       | Alarms 30, 60, 90, 120 seconds      | 60                        | 60                             |
| Alarm Volume                 | 1 to 10                             | 7                         | 7                              |

**Table 3: Parameter Ranges**

| <b>Parameter</b>          | <b>Ranges/<br/>Selections</b>   | <b>Factory Adult<br/>Defaults</b> | <b>Factory<br/>Neonate<br/>Defaults</b> |
|---------------------------|---|-----------------------------------|---|
| Alarms                    | Allow Off -<br>Yes/No   | Yes                               | Yes                                     |
|                           | Off Reminder -<br>Yes/No  | Yes                               | Yes                                     |
| Data Port Baud<br>Rate    | 2400, 9600,<br>19200  | 9600                              | 9600                                    |
| Data Port Mode            | ASCII, GRAPH,<br>OXINET,<br>CLINICAL,<br>AGILENT (HP<br>Agilent),<br>SPACELBS,<br>MARQ (GE<br>Marquette),<br>DATEX (Datex-<br>Ohmeda) | ASCII                             | ASCII                                   |
| Default Display<br>Format | Pleth, Blip   | Pleth                             | Pleth                                   |
| Default Trend<br>Display  | Saturation, Pulse<br>Rate, Dual,<br>Histogram   | Saturation                        | Saturation                              |
| Display<br>Contrast       | Low to high   | Medium                            | Medium                                  |
| Language                  | English, French,<br>German, Dutch,<br>Portuguese,<br>Spanish, Italian,<br>Swedish   | English                           | English                                 |
| Limits                    | Adult, Neonate  | Adult                             | Neonate                                 |
| Pulse Beep<br>Volume      | 0 to 10   | 4                                 | 4                                       |
| Response<br>Mode          | Normal or Fast  | Normal                            | Normal                                  |

**Table 3: Parameter Ranges**

| Parameter   | Ranges/<br>Selections  | Factory Adult<br>Defaults | Factory<br>Neonate<br>Defaults |
|---|--|---------------------------|--------------------------------|
| RS-232 Level<br>Nurse Call<br>Polarity                        | Normally High,<br>Normally Low   | Normally low              | Normally low                   |
| <i>SatSeconds</i>   | Off, 10, 25, 50,<br>100  | Off                       | Off                            |
| Sensor Event<br>Date Format<br>(SENSOR-R<br>and<br>SENSOR-RW) | SpO <sub>2</sub> ,<br>SpO <sub>2</sub> +Pulse Rate,<br>Default (default is<br>factory default) | Default                   | Default                        |
| Sensor<br>Messages<br>Enabled                                 | Yes, No  | Yes                       | Yes                            |
| Trend Display   | Dual, %SpO <sub>2</sub> ,<br>Pulse, Histogram,<br>Amplitude                                    | %SpO <sub>2</sub>         | %SpO <sub>2</sub>              |
| Trend Scale   | 48, 36, 12,8, 4, 2,<br>1 hours, 30, 15<br>minutes, 40, 20<br>seconds                           | 2 hours                   | 2 hours                        |

## Turning On the Monitor

Before using the N-595 in a clinical setting, you must verify that the monitor is working properly and is safe to use. Proper working condition will be verified each time the N-595 is turned on as described in the following procedure.



**Caution: If any indicator or display element does not light when the pulse oximeter is turned on, do not use the pulse oximeter. Instead, contact qualified service personnel, your local Nellcor representative, or Nellcor's Technical Services Department.**

**Note:** Physiological conditions, medical procedures, or external agents that may interfere with the monitor’s ability to detect and display measurements, include dysfunctional hemoglobin, arterial dyes, low perfusion, dark pigment, and externally applied coloring agents such as nail polish, dye, or pigmented cream.

**Note:** The monitor automatically starts the Power-On Self-Test (POST), which tests the monitor circuitry and functions.



**Caution: During POST (immediately after power-up), confirm that all indicators light, all display segments turn on, and the pulse oximeter speaker sounds a one-second tone.**



1. Turn on the N-595 by pressing the ON/STANDBY button.
2. Ensure that all of the front panel indicators illuminate.
3. Once the display test portion of POST is complete, the N-595 software version is displayed for approximately 5 seconds.



**Note:** The software version shown above is only a sample. Check your monitor for the software version installed.

Software version numbers are often needed when calling Nellcor’s Technical Services Department or your local Nellcor representative for technical assistance. Write down the software version number and have it available prior to requesting technical assistance.



- If the N-595 detects an internal problem during POST, an error tone sounds and the monitor displays an error code (EEE) and the corresponding number (see *Troubleshooting* on page 117).

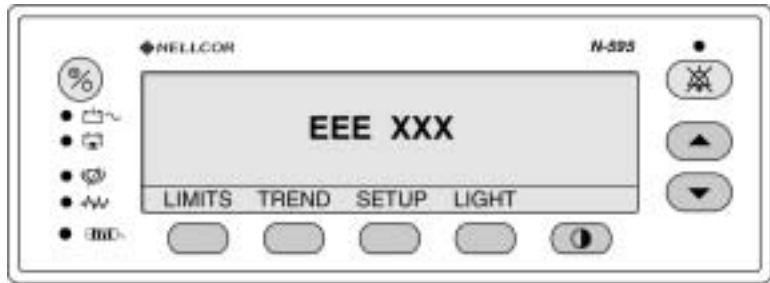

- Upon successful completion of the POST, the N-595 sounds a one-second tone indicating that the monitor has passed the test.



**WARNING:** If you do not hear the POST pass tone, do not use the pulse oximeter.



**WARNING:** Ensure that the speaker is clear of any obstructions. Failure to do so could result in an inaudible alarm tone.

**Note:** In addition to serving as the POST pass verification, the POST pass tone also functions as an audible confirmation that the speaker is performing properly. If the speaker does not function, the alarm warning sounds cannot be heard.

## OxiMAX Sensor Attached

When an *OxiMAX* sensor is attached to the monitor, a “DATA TYPE: . . .” message is displayed briefly at the bottom of the monitor display. For a sensor containing data, the message identifies the sensor data type, For a blank sensor, the message identifies the monitor’s current

data type setting that will be used to write data to the sensor. The data type settings are SPO2 and SPO2+BPM.

**Note:** The type of data recorded is only displayed when data is resent in the *OxiMAX* sensor.

The monitor displays zeros in the %SpO2 and Pulse Rate displays while the N-595 is searching for a valid pulse. For optimal performance, allow the monitor to search and lock onto a pulse for approximately 10 seconds in non-motion conditions.

When a valid pulse is detected, the monitor enters the Monitoring Mode and displays patient parameters.

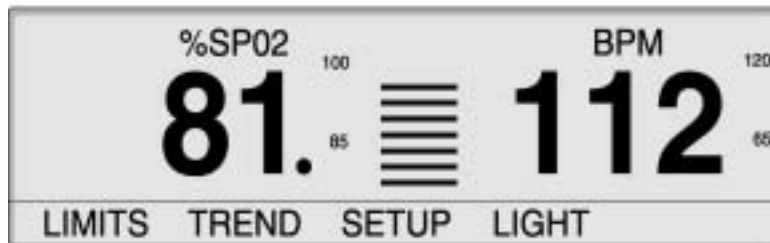
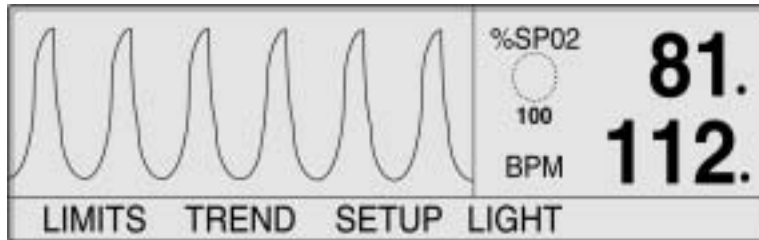

Look for movement of the blip bar or of the plethysmographic waveform indicating that the monitor is displaying real-time data. Listen for the pulse beep tone. If the pulse beep tone does not sound with each pulse, it is an indication that the pulse beep volume is set to zero, the speaker is malfunctioning, or the signal is corrupted.

When an *OxiMAX* sensor is attached to the monitor and is applied to a patient, if the monitor loses the pulse signal, the monitor will display “--- & ---” (3 dashes and 3 dashes) and remain in Pulse Search Mode for 5 seconds before displaying the poor signal condition screen. The poor signal condition screen is part of the N-595's Sensor Messages

feature. For more information about *OxiMAX* Sensor Messages, refer *OxiMAX Sensor Messages* on page 49.

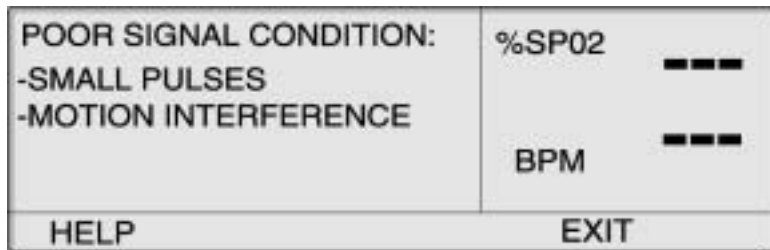

## No *OxiMAX* Sensor Attached

Upon successful completion of the POST, the N-595 monitor sounds a one-second tone indicating that the monitor has passed POST.

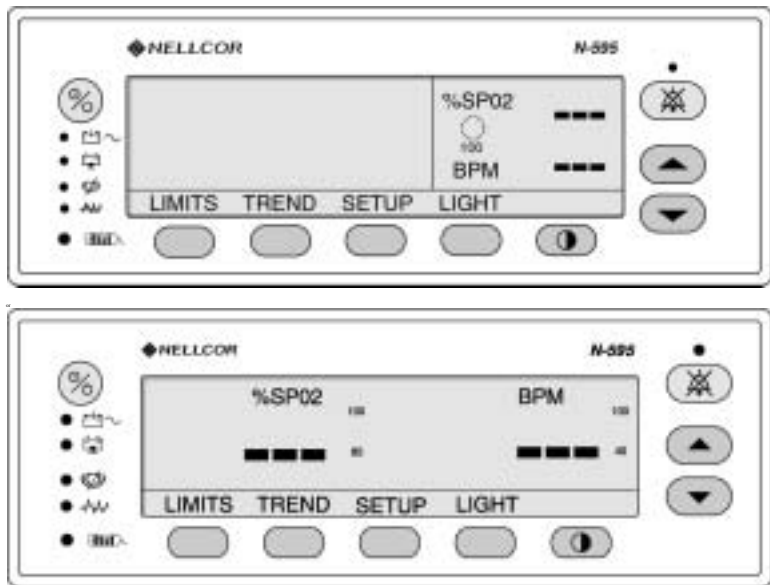

The monitor displays dashes (---) and the Pulse Search indicator is not lit, indicating that the monitor failed to detect an *OxiMAX* sensor.

---

## Turning the Backlight On or Off

**Note:** When the backlight is off, any of the following conditions will turn on the backlight:

- pressing any of the softkeys
- pressing the CONTRAST button
- pressing the ALARM SILENCE button
- any alarm

**LIGHT** With the monitor in the normal monitoring mode, press the LIGHT softkey.



---

## Adjusting Screen Contrast

With the monitor in the normal monitoring mode:



1. Press the CONTRAST button.



2. Press the ADJUST UP or ADJUST DOWN button until the desired contrast is obtained.



3. Press the CONTRAST button.

---

## Selecting the Pleth View

The pleth view displays the pleth waveform, %SpO<sub>2</sub>, and pulse rate data. Refer to *Principles of Operation* on page 143, for a description of the pleth waveform.

With the monitor in the normal monitoring mode:

- SETUP** 1. Press the SETUP softkey.



- VIEW** 2. Press the VIEW softkey.



- PLETH** 3. Press the PLETH softkey.

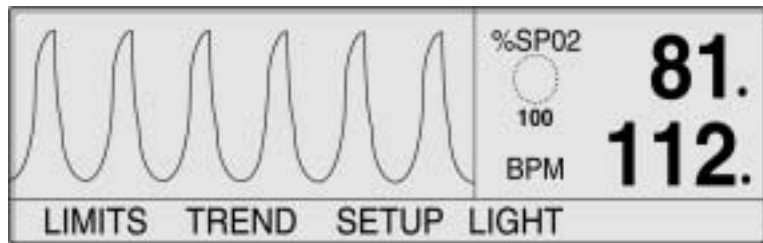

## Selecting the Blip View

Displays SpO<sub>2</sub>, pulse rate, blip bar, and limits in a larger format for easier viewing.

With the monitor in the normal monitoring mode:

- SETUP** 1. Press the SETUP softkey.



- VIEW** 2. Press the VIEW softkey.





3. Press the BLIP softkey.

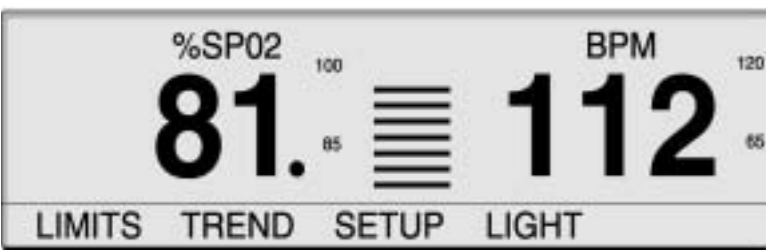

---

## Setting the Pulse Beep Volume

With the monitor in the normal monitoring mode:



1. Press and hold the ADJUST UP/ADJUST DOWN button to increase/decrease pulse beep volume.

---

## Setting the Alarm Volume

The Alarm Volume display allows the user to adjust the volume of alarm tones.

With the monitor in the normal monitoring mode:



1. Press the ALARM SILENCE button until the alarm volume level is displayed and sounds on the monitor.

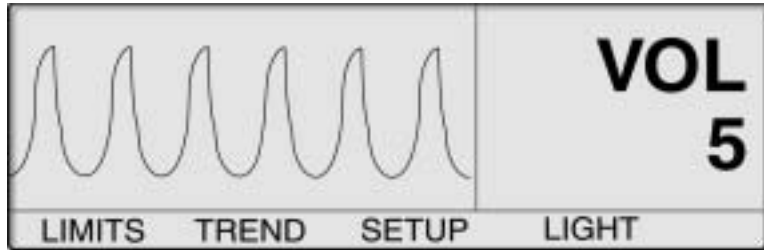

2. While continuing to press the ALARM SILENCE button, press and hold the ADJUST UP/ADJUST DOWN button to increase/decrease the volume.

## Setting the Date and Time





**WARNING:** The sensor extrapolates from the date and time provided by the N-595 when recording the sensor event record to the sensor. The accuracy of the date/time is the responsibility of the N-595. It is recommended that the N-595 user set the time/date to the correct value before a sensor event record-enabled sensor is connected, and that this date/time not be changed while the sensor remains connected. Since a sensor with sensor event record data can be transported from one monitor to another, having discrepancies in the date/time between monitors and the sensor event record data will affect the order the sensor event record data appears. To eliminate this possible problem, all monitors within an institution should be set to the same time.

With the monitor in the normal monitoring mode:

SETUP







1. Press the SETUP softkey.

- 2. Press the NEXT softkey.  

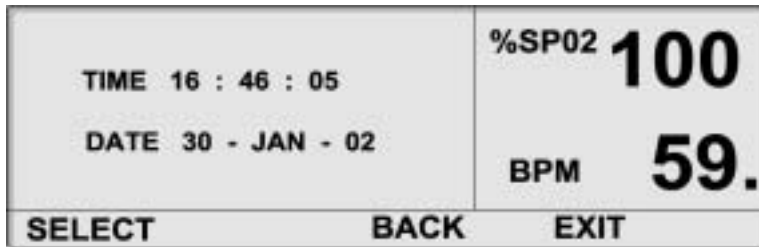
- 3. Press the CLOCK softkey.  

- 4. Press the SET softkey.  

- 5. Press the SELECT softkey to select:

TIME HOURS : MINUTES : SECONDS (16:46:05)

DATE DAY - MONTH - YEAR (30-JAN-02)



- 6. Use the ADJUST UP or ADJUST DOWN buttons to change the selected value.  
  

- 7. Press the EXIT softkey.  

## Setting Alarm Silence Duration

The Alarm Silence Duration display allows the user to adjust the alarm silence duration.

With the monitor in the normal monitoring mode:





1. Press the ALARM SILENCE button until the alarm silence duration setting is displayed. Alarm silence durations that are available are OFF, 30, 60, 90, and 120 seconds.



2. Press and hold the ALARM SILENCE button and the ADJUST UP button to increase the alarm silence duration setting.



3. Press and hold the ALARM SILENCE button and the ADJUST DOWN button to decrease the alarm silence duration setting.

**Note:** Releasing the ADJUST UP or ADJUST DOWN button sets the alarm silence duration.

## Disabling Audible Alarms

Setting the alarm silence duration to OFF means that the monitor will produce no audible alarms.

**Note:** The ability to set the alarm silence duration to OFF can be enabled or disabled by qualified service personnel as described in the service manual. The current copy of the service manual is available on the Internet at:

[http://www.mallinckrodt.com/respiratory/resp/Serv\\_SuppProductManuals.html](http://www.mallinckrodt.com/respiratory/resp/Serv_SuppProductManuals.html)



**WARNING: Do not silence the audible alarm function or decrease the audible alarm volume if patient safety could be compromised.**

With the monitor in the normal monitoring mode:



1. Press the ALARM SILENCE button until the alarm silence duration setting is displayed.

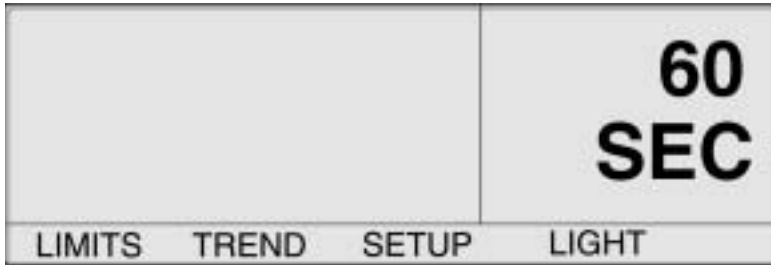

2. While pressing the ALARM SILENCE button, press and hold the ADJUST UP button until OFF is displayed. Release the buttons.





## Selecting Standby Mode

The standby mode allows the monitor to retain the alarm limit settings that are in effect while monitoring a patient. The monitor must be powered by AC power to enter the standby mode.

Usually the standby mode is used when a patient has to leave the monitor for a period of time and will return to the same monitor.

To place a monitor in the standby mode:

1. The monitor should be monitoring a patient.
2. The monitor alarm limits should be configured to the patient being monitored.
3. Disconnect the sensor from the monitor.
4.  Press the ALARM SILENCE button. This silences the audible alarms.
5.  Press the ALARM SILENCE button. This disables the alarm messages.

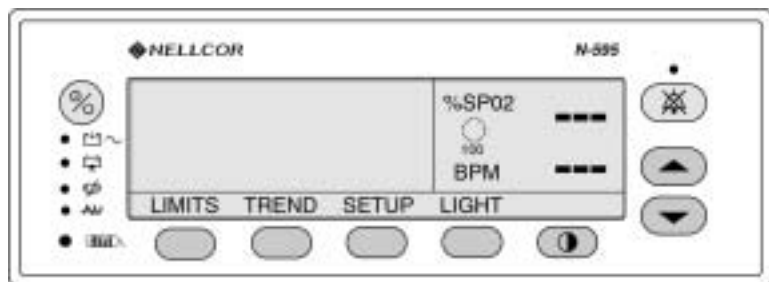

The monitor is now in standby. To return to normal monitoring, connect the sensor to the monitor and the patient.

---

## Adult-Pediatric or Neonatal Settings

The clinician can set the monitor's operating mode to adult-pediatric or neonatal by using the LIMITS softkey. The setting will only remain in the monitor until the monitor is turned off. The factory default power-on setting is for adult-pediatric patients. This default setting can be changed to neonatal by qualified service personnel using the procedures indicated in the service manual.

Refer to Table 11 on page 139, for neonate factory default limit settings. Refer to Table 12 on page 140, for adult factory default limit settings.



---

**WARNING: Each time the pulse oximeter is used, check alarm limits to ensure that they are appropriate for the patient being monitored.**

---

---

## Setting Patient Adult-Pediatric/Neonatal Mode

With the monitor in the normal monitoring mode:

**LIMITS**

1. Press the LIMITS softkey.

| ADULT LIMITS |       |       | %SP02 | ---- |
|--------------|-------|-------|-------|------|
|              | %SPO2 | BPM   | ○     | ---- |
| UPPER        | 100   | 170   | 100   | ---- |
| LOWER        | 85    | 40    |       | ---- |
| SAT-S        | 100   |       | BPM   |      |
| SELECT       | NEO   | ADULT |       |      |

| NEONATE LIMITS |       |       | %SP02 | ---- |
|----------------|-------|-------|-------|------|
|                | %SPO2 | BPM   | ○     | ---- |
| UPPER          | 95    | 190   | 100   | ---- |
| LOWER          | 80    | 90    |       | ---- |
| SAT-S          | 100   |       | BPM   |      |
| SELECT         | NEO   | ADULT | EXIT  | NEO  |

2. The monitor will display the ADULT LIMITS or NEONATE LIMITS screen, depending on the patient setting being used.

**ADULT or  
NEO**

3. Press the NEO or ADULT softkey to select ADULT LIMITS or NEONATE LIMITS as applicable for the patient being monitored.

## Alarm Limit Changed Indicator

Alarm limits that have been changed from the institutional or factory default settings are identified by a decimal point (.) after the displayed reading (%SpO2 or BPM). The changed parameter is also identified by a decimal point on the alarm limits screen.

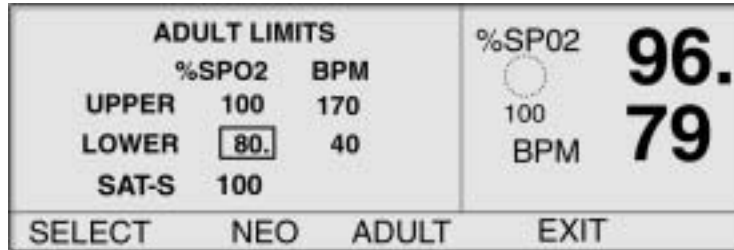

## Setting Alarm Limits

The Alarm Limit display allows the user to adjust the upper and lower saturation and pulse rate limits. It also allows the user to adjust the *SatSeconds* limit.

The Alarm Limit display is accessed by pressing the LIMITS softkey on the Main menu.

The Alarm Limit display includes the alarm limit table and current measured %SpO2 and pulse rate. The title of the alarm limit table will indicate whether the instrument is in Adult or Neonate monitoring mode. If *SatSeconds* are enabled, the Alarm Limit display also includes the *SatSeconds* indicator. Decimal points after the displayed %SpO2 or pulse rate indicate that the respective limits have been changed from the power-on defaults.

With the monitor in the normal monitoring mode:

**LIMITS**

1. Press the LIMITS softkey. Current alarm limits are displayed.

| ADULT LIMITS |       |       | %SP02 | --- |
|--------------|-------|-------|-------|-----|
|              | %SPO2 | BPM   | 100   | --- |
| UPPER        | 100   | 170   |       |     |
| LOWER        | 85    | 40    |       |     |
| SAT-S        | 100   |       | BPM   | --- |
| SELECT       | NEO   | ADULT | EXIT  |     |

or

| NEONATE LIMITS |       |       | %SP02 | --- |
|----------------|-------|-------|-------|-----|
|                | %SPO2 | BPM   | 100   | --- |
| UPPER          | 95    | 190   |       |     |
| LOWER          | 80    | 90    |       |     |
| SAT-S          | 100   |       | BPM   | --- |
| SELECT         | NEO   | ADULT | EXIT  | NEO |

**ADULT or  
NEO**

2. Press the ADULT or NEO softkey to select Adult-Pediatric or Neonatal alarm limits screen.

**SELECT**

3. Press the SELECT softkey as required to select the parameter to be adjusted.



4. Use the ADJUST UP or ADJUST DOWN buttons to increase or decrease the selected limit parameter.

5. Repeat steps 3, 4, and 5 as necessary to complete the alarm limits setup.

**EXIT**

6. To accept the changes, let the display time-out or press the EXIT softkey to exit the display and return to normal monitoring.

**Note:** Limit changes will only be in effect as long as the monitor remains turned on. When the monitor is turned off, the institutional or factory default limits will be restored into the monitor. When the monitor is turned on, the institutional or factory default limits will be in effect. Factory or institutional defaults are selected by qualified service personnel following the procedure in the service manual.

## Setting SatSeconds Alarm Limit

Refer to *Describing SatSeconds* on page 135, for a description of the *SatSeconds* function.

With the monitor in the normal monitoring mode:

- LIMITS** 1. Press the LIMITS softkey. Current alarm limits are displayed.



- SELECT** 2. Press the SELECT softkey twice to select %SpO2 SAT-S.



| ADULT LIMITS |                                  |       | %SP02 |      |
|--------------|----------------------------------|-------|-------|------|
|              | %SPO2                            | BPM   |       |      |
| UPPER        | 100                              | 170   |       | ---- |
| LOWER        | 80.                              | 40    | 100   | ---- |
| SAT-S        | <input type="text" value="100"/> |       | BPM   |      |
| SELECT       | NEO                              | ADULT | EXIT  |      |



3. Use the ADJUST UP or ADJUST DOWN buttons to select the limit. The choices are 10, 25, 50, or 100 seconds or OFF.

**EXIT**



4. Press the EXIT softkey to save your choice.



---





## Setting Monitor Response Mode

The purpose of the response mode is to set the response time of the OxiMAX algorithm calculation of the SpO<sub>2</sub> (the response mode does not affect the OxiMAX algorithm's calculation of pulse rate). The trending interval (2- or 4-seconds) is updated automatically by the monitor to roughly correspond with the SpO<sub>2</sub> calculation response time.

The response mode programs the OxiMAX algorithm to display monitor trend information at 2-second intervals (Fast Mode) or 4-second intervals (Normal Mode).

The response mode display screen includes the current SpO<sub>2</sub> response mode setting and the current measured %SpO<sub>2</sub> and pulse rate. When in the fast mode, the screen displays the fast mode symbol.

With the monitor in the normal monitoring mode:

1. Press the SETUP softkey.  

2. Press the NEXT softkey.  

3. Press the NEXT softkey.  

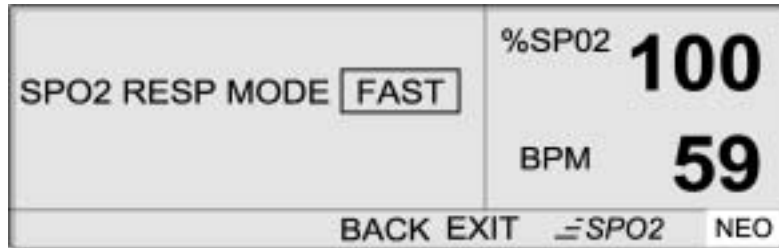
4. Press the NEXT softkey.  

5. Press the MODE softkey.  

**Note:** When the monitor is in the fast response mode the monitor may produce more SpO<sub>2</sub> and pulse rate alarms than the user is

accustomed to seeing, and may be inappropriate in challenging measurement conditions.



6. Use the ADJUST UP or ADJUST DOWN buttons to select the desired response mode.



7. Press the EXIT softkey.

## Selecting the Display Language

The N-595 can be programmed to display the information in various languages. The languages available are English, Francais (French), Deutsch (German), Italiano (Italian), Espanol (Spanish), Nederlands (Dutch), Port (Portuguese) and Sverige (Swedish).

With the monitor in the normal monitoring mode:



1. Press the SETUP softkey.



2. Press the NEXT softkey.

LANG



3. Press the LANG softkey.

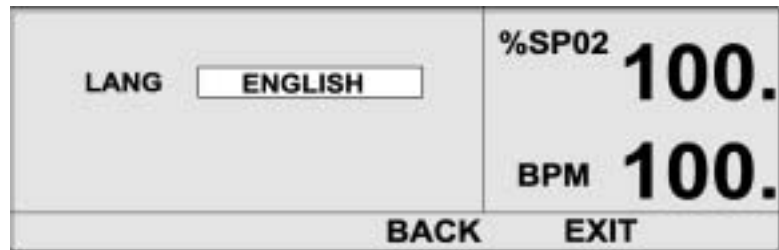

4. Use the ADJUST UP or ADJUST DOWN buttons to select the desired language.

EXIT



5. Press the EXIT softkey.

**Note:** The selected language will be displayed until the monitor is turned off. The selected language can be set as a default by qualified service personnel following the procedures in the service manual.

## OxIMAX Sensor Messages

*OxIMAX* sensor messages consist of sensor adjust condition messages and sensor adjust messages which, when enabled, are displayed when the monitor is not able to display saturation. When *OxIMAX* sensor messages are displayed, it is an indication that the *OxIMAX* sensor is functioning correctly, but the site to which the *OxIMAX* sensor applies or the application method is not optimal for calculating %SpO<sub>2</sub>. Condition messages are followed by action messages. Up to three condition messages may be displayed on the “POOR SIGNAL CONDITION” display in priority order, highest on top. The condition display may be dismissed by using the EXIT softkey. Once exited, the

*OxiMAX* sensor message screen will not return until a new condition occurs.

|   |              |            |
|---|--------------|------------|
| POOR SIGNAL CONDITION:<br>-SMALL PULSES<br>-MOTION INTERFERENCE | %SP02<br>BPM | ---<br>--- |
| HELP  | EXIT         |            |

If the HELP softkey is pressed from the Condition message display, the action messages are displayed. Action messages are linked to the sensor type; action messages will be displayed for the type of *OxiMAX* sensor connected to the monitor. Up to five action messages may be displayed. Multiple screens may be required to display all of the messages. When multiple screens are required, navigation between screens can be accomplished through the NEXT, BACK, and EXIT softkeys.

*OxiMAX* sensor messages may be disabled. Refer to *OXIMAX Sensor Message Setup* on page 127 for selecting the *OxiMAX* Sensor Messages, Enable/Disable function.

|  |              |            |
|--|--------------|------------|
| SUGGESTED ACTION:<br>-REPOSITION SENSOR<br>-CLEAN SENSOR SITE<br>-NASAL/EAR SENSOR | %SP02<br>BPM | ---<br>--- |
| NEXT   | BACK         | EXIT       |

### ***OxiMAX* Sensor Adjust Condition Messages**

- Condition 1 — SENSOR OFF?
- Condition 2 — SMALL PULSES
- Condition 3 — WEAK SIGNAL

- Condition 4 — MOTION INTERFERENCE
- Condition 5 — EXCESS INFRARED LIGHT
- Condition 6 — ELECTRICAL/LIGHT INTERFERENCE
- Condition 7 — HIGH PULSE AMPLITUDE

---

## **OxiMAX Sensor Adjust Messages**

- Message 1 — ALTERNATE SITE?
- Message 2 — COVER SENSOR SITE?
- Message 3 — EAR/FOREHEAD SENSOR?
- Message 4 — NASAL/EAR SENSOR?
- Message 5 — *OxiMAX* ADHESIVE SENSOR
- Message 6 — SECURE CABLE
- Message 7 — HEADBAND
- Message 8 — WARM SITE
- Message 9 — BANPAGE ASSEMBLY
- Message 10 — NAIL POLISH
- Message 11 — SENSOR TOO TIGHT?
- Message 12 — REPOSITION SENSOR
- Message 13 — ISOLATE INTERFERENCE SOURCE
- Message 14 — CLEAN SENSOR SITE



---

## Monitor Trend Data

The trend displays allow the user to view trend data. Two types of trend data can be viewed:

- Monitor trend data which are stored in the monitor
- Patient event data which are stored in the *OxiMAX* sensor (single-patient-use *OxiMAX* sensors only) and can be used with the sensor event record feature.

Monitor trend data can be viewed anytime patient trend is stored in the monitor. Monitor trend displays are accessed by pressing the TREND softkey on the main menu and selecting the MONITR softkey option. The monitor trend sub-menu allows you to choose which trend data are displayed:

- Saturation and pulse rate (Dual)
- Saturation
- Pulse rate
- Pulse amplitude
- Histogram

The N-595 can graphically display trend data for SpO<sub>2</sub>, pulse rate, or both. Trend data is stored at 2- or 4-second intervals. When the TREND softkey is pressed, “READING TRENDS . . .” is displayed at the bottom of the N-595 screen, indicating that the monitor is formatting the trend data to be displayed.

The monitor stores up to 48 hours of 4-second trend data or 24 hours of 2-second trend data. The amount of trend data displayed on the screen is determined by using the ZOOM softkey. The settings available are 20 and 40 seconds, 15 or 30 minutes, and 1, 2, 4, 8, 12, 24, 36, or 48 hours. All trend data are displayed in a graphical format except the 20- and 40-second trend displays, which are shown in tabular format.

The trend display is scrolled, that is, the data displayed can be moved throughout the 48 hours of trend data. Selecting the 1-hour trend display allows you to view one hour of trend information. By using the scrolling feature, any one hour of trend data can be viewed over the 48 hours of trend information. The ADJUST DOWN button scrolls the display to the left and the ADJUST UP button scrolls the display to the right.

When the data are displayed, the most recent readings are on the right side of the graph. The numbers below %SpO<sub>2</sub> indicate the highest and lowest parameter values at the cursor position (vertical dotted line on the display). See Table 4 on page 57.

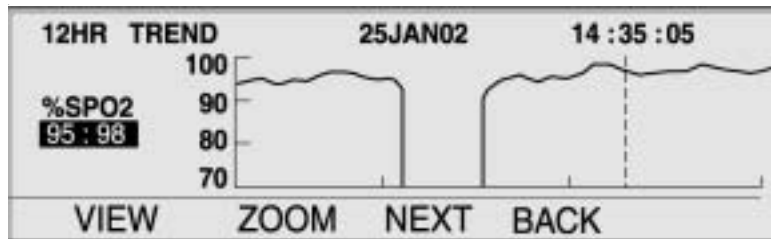

Trend data is further explained in *Specifications* on page 147.

Trend data information may be retrieved through the N-595 data port or cleared using options available in a display menu.



**Caution: Monitor trend data will be lost if the main battery fails or is removed.**



## Trend Data Operation

Whenever the N-595 is turned on, it stores the monitor %SpO<sub>2</sub> and pulse rate readings in memory every 2 or 4 seconds (regardless of whether the N-595 is monitoring a patient or not). The N-595 can store up to 48 hours of 4-second trend data or 24 hours of 2-second trend data. The 48/24 hours of stored trend data are available for downloading to a printer or a portable computer. Up to 50 alarm limit changes can be stored in the trend data. If more than 50 alarm limit changes occur during the 48/24 hours of trend data collection, the additional alarm limit changes will take space reserved for trend data.



**Caution: Changing alarm limit settings uses up trend memory space. Change alarm limits only as needed.**

**Note:** Trend memory always contains the most recent 48 hours of data, with newly collected data overwriting the oldest data on a rolling basis. The N-595 continues to record data points as long as the monitor is powered on, with “blank” data points collected if no *OxIMAX* sensor is connected to the monitor or patient. “Blank” data will over-write older patient data if the memory becomes full. Therefore, if you want to save old patient data, it is important that you turn your monitor off when you are not monitoring a patient, and that you download the trend memory before it fills up and over-writes the old data with new data (or “blank” data).



## Selecting the Trend Data Display Scale

The trend scale is the amount of trend data displayed on the screen.

With the monitor in the normal monitoring mode:

1. Press the TREND softkey.
2. Press the MONITR softkey.



- VIEW**
- 
- 
3. Press the VIEW softkey.
  4. Press any of the trend softkeys (DUAL, SPO2, or PULSE). To select HIST (histogram) or AMP (amplitude), press the NEXT softkey and then the HIST or AMP softkeys.

- ZOOM**
- 
5. Press the ZOOM softkey. The Zoom menu is displayed.

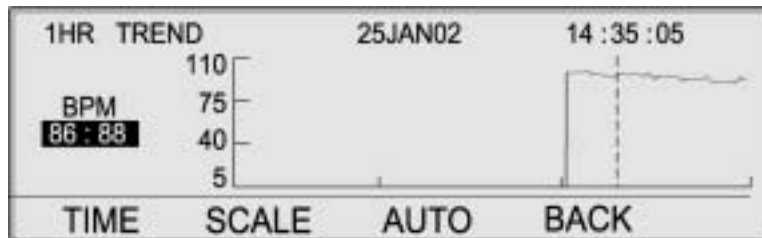

- TIME**
- 
- Pressing the TIME softkey cycles the displayed trend time scale through 48 hours, 36 hours, 12 hours, 8 hours, 4 hours, 2 hours, 1 hours, 30 minutes, 15 minutes, 40 seconds and 20 seconds.

**Note:** The 20-second and 40-second trend displays are in tabular format. The below display starts out in the normal response mode (left side of the display) and switches to the fast response mode.

| 40SEC TREND |       |     | 05JAN02  |       | 21:31:48 |  |
|-------------|-------|-----|----------|-------|----------|--|
| TIME        | %SPO2 | BPM | TIME     | %SPO2 | BPM      |  |
| 21:31:30    | 96    | 78  | 21:31:40 | 97    | 78       |  |
| 21:31:28    | --    | --  | 21:31:38 | 97    | 79       |  |
| 21:31:26    | 97    | 78  | 21:31:36 | 97    | 80       |  |
| 21:31:24    | --    | --  | 21:31:34 | 96    | 78       |  |
| 21:31:22    | 97    | 78  | 21:31:32 | 96    | 78       |  |

TIME SCALE AUTO BACK \_=SPO2

- SCALE**
- 
- Pressing the SCALE softkey cycles the displayed trend amplitude scale through  $\pm 5$  points,  $\pm 10$  points,  $\pm 15$  points,  $\pm 20$  points,  $\pm 25$  points,  $\pm 30$  points,  $\pm 35$  points,  $\pm 40$  points and  $\pm 50$  points above and below the data point under the cursor. The saturation graphical monitor trend display vertical scale default setting is from 10 to 100 if there is no data under the cursor. The pulse rate graphical monitor

trend display vertical scale is from 5 to 250 if there is no data under the cursor.

**AUTO** Pressing the AUTO softkey presets the amplitude of the graphed trend data. The maximum trend data point is rounded up to the nearest multiple of 10, this value is the top of the graph display. The minimum trend data point is rounded down to the next multiple of 10. Then 10 is subtracted from the rounded down number, this value is the bottom of the trend graph.

**BACK** Pressing the BACK softkey returns the monitor to the Monitor menu.

## Reading the Trend Data Display

Table 4 identifies the components of the trend data display.

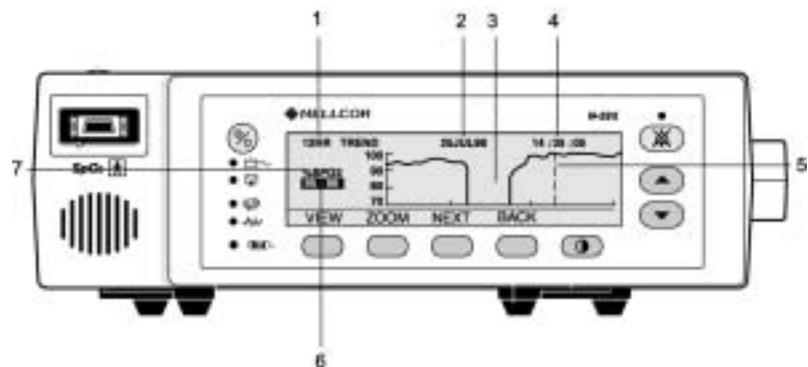

**Table 4: Reading Trend Display**

| Item | Description  |
|------|--|
| 1    | Amount of trend data displayed on the screen. Settings available are 20 and 40 seconds, 15 and 30 minutes, 1, 2, 4, 8, 12, 24, 36, and 48 hours. |
| 2    | Date represented by the cursor (item 5).   |
| 3    | No trend data recorded during this time.   |
| 4    | Time represented by the cursor (item 5).   |

**Table 4: Reading Trend Display**

| Item | Description  |
|------|--|
| 5    | Cursor - can be moved left or right using the ADJUST UP (right) or ADJUST DOWN (left) buttons. |
| 6    | Highest and lowest reading at the cursor position.   |
| 7    | Trend data that is being displayed (%SPO2, BPM, or PAU [pulse amplitude units]).               |

## Dual Trend Data Display

The dual trend data display displays both oxygen saturation (%SpO2) levels and pulse rate (bpm) trend data.



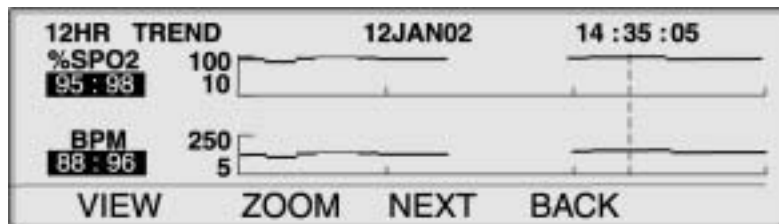

With the monitor in the normal monitoring mode:

- TREND** 1. Press the TREND softkey.
- MONITR** 2. Press the MONITR softkey.
- VIEW** 3. Press the VIEW softkey.
- DUAL** 4. Press the DUAL softkey. The dual trend (%SpO2 and Pulse Rate) is displayed.



## SpO<sub>2</sub> Trend Display

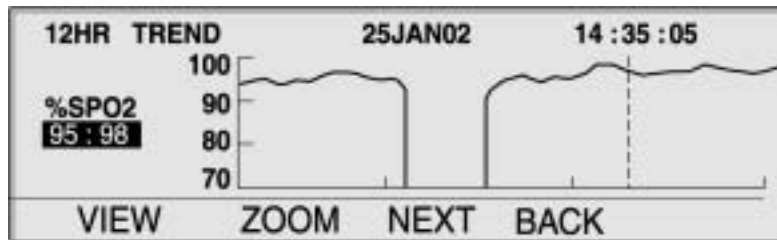

With the monitor in the normal monitoring mode:

- TREND** 1. Press the TREND softkey.  

- MONITR** 2. Press the MONITR softkey.  

- VIEW** 3. Press the VIEW softkey.  

- SPO2** 4. Press the SPO2 softkey. SpO<sub>2</sub> trend data is displayed.  



## Pulse Rate Trend Display

With the monitor in the normal monitoring mode:

- TREND** 1. Press the TREND softkey.  

- MONITR** 2. Press the MONITR softkey.  

- VIEW** 3. Press the VIEW softkey.  

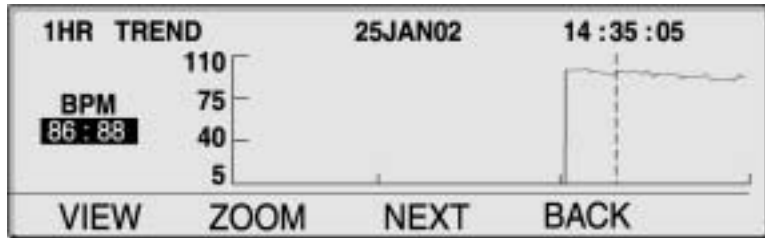

4. Press the PULSE softkey. The pulse trend data is displayed.



## Histogram Trend Data Display

The histogram displays trend data for the percent of oxygen blood saturation (SpO<sub>2</sub>) and pulse rate (bpm). The data displayed represents the trend data stored over the period of time indicated on the display. Refer to *Selecting the Trend Data Display Scale* on page 55, to set up the desired trend data scale.

Pulse amplitude cannot be displayed on the histogram display.

With the monitor in the normal monitoring mode:



1. Press the TREND softkey.



2. Press the MONITR softkey.



3. Press the VIEW softkey.



4. Press the NEXT softkey.

HIST



- Press the HIST softkey. The Histogram trend data is displayed.

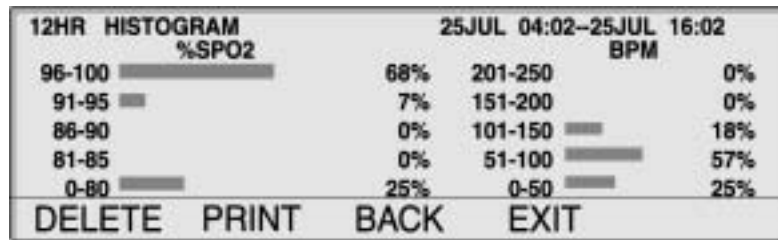

## Pulse Amplitude Trend Data Display

The pulse amplitude trend data display shows the amplitude of the patient's pulse rate over the period of time indicated on the display. Refer to *Selecting the Trend Data Display Scale* on page 55, to setup the desired trend data scale.

With the monitor in the normal monitoring mode:

TREND



- Press the TREND softkey.

MONITR



- Press the MONITR softkey.

VIEW



- Press the VIEW softkey.

NEXT



- Press the NEXT softkey.



5. Press the AMP softkey. The pulse amplitude units (PAU) trend data is displayed.

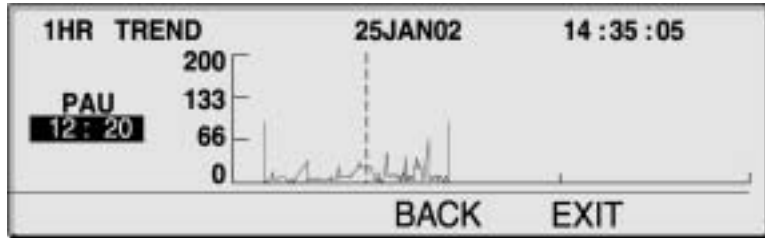

The PAU reading (12 : 20) indicates the pulse amplitude units (upper and lower) at the cursor position (dashed line). The cursor is moved right or left using the ADJUST UP (right) and ADJUST DOWN (left) buttons.

## Clearing Trend Information

With the monitor in the normal monitoring mode:



1. Press the TREND softkey.



2. Press the MONITR softkey.



3. Press the NEXT softkey.



4. Press the DELETE softkey.

**Note:** Press the NO softkey and then the EXIT softkey to leave this function without deleting trend data.



5. Press the YES softkey.



All the trend data is cleared and the monitor sounds three beeps.



# *OxIMAX Sensor Event Record*

---



**WARNING:** The sensor extrapolates from the date and time provided by the N-595 when recording the sensor event record to the sensor. The accuracy of the date/time is the responsibility of the N-595. It is recommended that the N-595 user set the time/date to the correct value before a sensor event record-enabled sensor is connected, and that this date/time not be changed while the sensor remains connected. Since a sensor with sensor event record data can be transported from one monitor to another, having discrepancies in the date/time between monitors and the sensor event record data will affect the order the sensor event record data appears. To eliminate this possible problem, all monitors within an institution should be set to the same time.

---

The adhesive *OxIMAX* sensors are capable of storing patient event data. A sensor event record allows alarm event history to travel with the patient on the sensor's memory chip for quick assessment at every point of care where *OxIMAX* monitors are used.

Patient (event) data is stored on the memory chip of adhesive *OxIMAX* sensors (single-patient-use *OxIMAX* sensors only). The event data is stored (recorded) with the limit/threshold settings that were active at the time of the event on the recording monitor. These events can be viewed on the next *OxIMAX* sensor monitor when the patient moves to a new point of care.

An event occurs when the %SpO<sub>2</sub> value exceeds either the upper or lower alarm limit for at least 15 seconds. The first *OxIMAX* sensor event record event will be stored in the *OxIMAX* sensor after the *OxIMAX* sensor has been attached to a patient for five minutes and every five minutes thereafter. The maximum number of events that can be stored in an *OxIMAX* sensor is 100.

Event records can only be viewed after an *OxiMAX* sensor containing patient data (event records) has been connected to an *OxiMAX* monitor. Event records are designed to view patient events from prior areas of care or transport (history) while monitor trend should be used to view data or events from a patient currently being monitored. The monitor's SENSOR EVENT RECORD indicator will light when an *OxiMAX* sensor containing event data is connected to the *OxiMAX* monitor.

*Patient* event data is accessed by pressing the TREND softkey on the main menu and selecting the SENSOR softkey option. Sensor event record can be viewed in graphical form (GRAPH) or in a summary table (TABLE).

**Note:** Once the *OxiMAX* sensor event record type is set up in the *OxiMAX* sensor and event data is stored in the *OxiMAX* sensor, the *OxiMAX* sensor event record type cannot be reset. The monitor's type set up can be changed at any time.

Recording and viewing of *OxiMAX* sensor event record is only available on *OxiMAX* comparable monitors. The *OxiMAX* sensors may function on older technology monitors but the *OxiMAX* sensor event record feature is not available.

Refer to the N-595 service manual for the procedure to disable the storage of sensor event record on an *OxiMAX* sensor.

---

## Setting In-Sensor Data Type

The In-Sensor Data Type display allows the user to set the type of trend data to be recorded in an *OxiMAX* sensor. *OxiMAX* sensors can be set to record either SpO<sub>2</sub> or SpO<sub>2</sub>+BPM.

**Note:** The *OxiMAX* sensor data type can only be set when an *OxiMAX* sensor is not connected to the monitor.

With the monitor turned on and no cable attached to the SpO<sub>2</sub> *OxiMAX* sensor port:

1. Press the SETUP softkey.



2. Press the SENSOR softkey.



3. Press the DATA softkey.



**Note:** *OxiMAX* sensor data type settings are displayed on the monitor as shown in the figure below (in-sensor data type). If no sensor is connected, both sensor types and the full set of options for each are displayed. If a sensor is connected, only the sensor data type for that sensor is displayed.

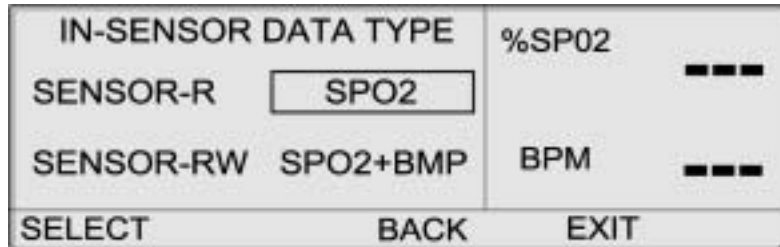

**Note:** The SENSOR-R feature supports all the current *OxiMAX* sensors. The SENSOR-RW feature is only applicable to *OxiMAX* sensors with a read/write chip installed.

4. Use the SELECT softkey to toggle between SENSOR-R and SENSOR-RW.





5. Use the ADJUST UP or ADJUST DOWN button to select the *OxiMAX* sensor data type. SENSOR-R and SENSOR-RW selections are:

- SpO2
- SpO2+BPM
- DEFAULT



6. Press the EXIT softkey to set the *OxiMAX* sensor type.

## OxiMAX Sensor Type

When an *OxiMAX* sensor is connected to the monitor, a “SENSOR TYPE: ...” message is displayed for 4 to 6 seconds at the bottom of the display. The message identifies the type (model) of *OxiMAX* sensor connected to the monitor. Type is used in the determination of action messages in the *OxiMAX* sensor message(s) function. This display is the first message displayed when an *OxiMAX* sensor is connected to the monitor.

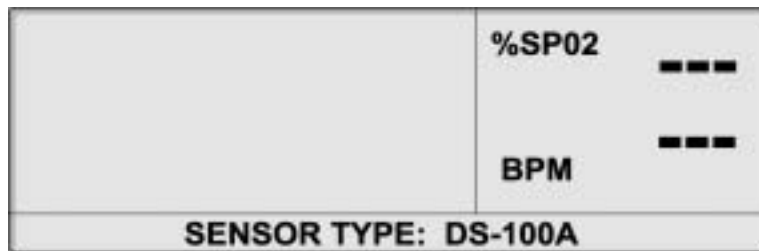

## OxiMAX Sensor Data Type

When an *OxiMAX* sensor with no previously recorded patient data is connected to the *OxiMAX* monitor, a “DATA TYPE: ...” message is displayed briefly at the bottom of the display, this message is

displayed after the *OxiMAX* sensor type message. The message identifies the monitor's current data type setting that will be used to write data to the *OxiMAX* sensor. The data type setting options are EVENT/SPO<sub>2</sub> and EVENT/SPO<sub>2</sub>+BPM.

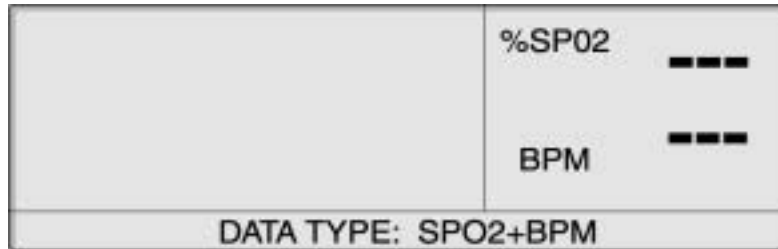

The user can change the setting by referring to *Setting In-Sensor Data Type* on page 66. The *OxiMAX* sensor event record type must be set prior to connecting the *OxiMAX* sensor to the monitor.

## OxiMAX Sensor Event Record Data Available



When an *OxiMAX* sensor containing data (single-patient-use *OxiMAX* sensors only) is connected to the monitor, the Sensor Event Record indicator on the monitor front panel blinks at a medium priority flash rate to indicate that the *OxiMAX* sensor attached to the monitor contains patient event data. The LED blinks for approximately 60 seconds or until the *OxiMAX* sensor is disconnected or until the sensor trend data is displayed by pressing TREND, then SENSOR.

A corresponding "DATA IN SENSOR" message is also displayed at the bottom of the display. After 4 to 6 seconds, if all the data has been read from the *OxiMAX* sensor, the message is replaced with the main menu.

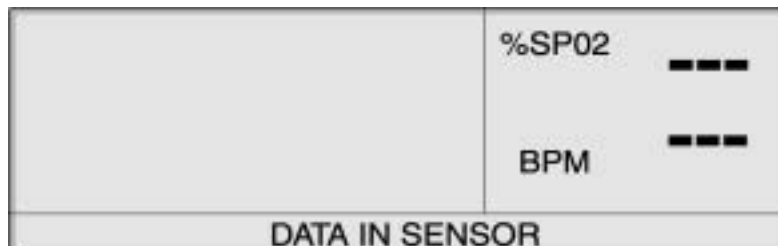

If data is still being read from the *OxiMAX* sensor, after 4 to 6 seconds, the DATA IN SENSOR message is replaced with a READING TRENDS message with an ABORT option.



Selecting the ABORT softkey stops the recording of additional data in the *OxiMAX* sensor and accessing or viewing the data that is in the *OxiMAX* sensor.

Sensor event record can be viewed by accessing the TREND/SENSOR menu.

The SENSOR EVENT RECORD LED comes on steady when *OxiMAX* sensor memory is full and stays on until the *OxiMAX* sensor is disconnected.

---

## **OxiMAX Sensor Event Record Not Available**

If the user selects the TREND/SENSOR option when a connected *OxiMAX* sensor (single-patient-use *OxiMAX* sensors only) does not contain data, because no events were recorded to the *OxiMAX* sensor memory chip in the prior monitoring situation, a “NO DATA” message is displayed on the default trend or event graph.



A sample event display in which no data are available is shown below. The message will be cleared when the graph or summary is exited.

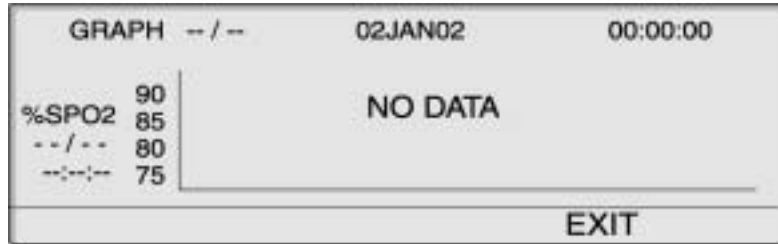

## OXIMAX Sensor Event Record Graphical Data

Graphical representations of patient event history is only available on single-patient-use *OxiMAX* sensors. Graphed data points are the minimum or maximum %SpO<sub>2</sub> value for each 30-second interval throughout the duration of an event (%SpO<sub>2</sub> continuously below alarm threshold for at least 15 seconds) and continuing every 30 seconds until the actual %SpO<sub>2</sub> value equals or exceeds the alarm threshold.

The duration of an event is determined by the number of data points in the event. Each data point is stored at 30-second intervals.

Events end for one of four reasons:

- The %SpO<sub>2</sub> returns to or above the alarm limit
- Loss of pulse
- The *OxiMAX* sensor is disconnected

- The *OxiMAX* sensor is off the patient

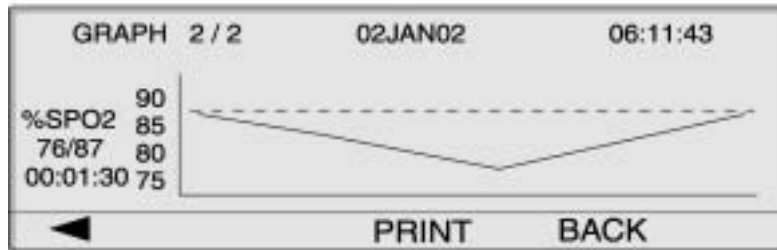

The graph title shows the data type (EVENT GRAPH) in the upper left corner. The number of the displayed event and the total number of events recorded in the *OxiMAX* sensor are shown to the right of the title (example, 2/2). The date and time of the displayed event are shown in the upper center and upper right corner.

The type of data displayed in the graph is indicated to the left of the vertical axis (%SpO<sub>2</sub>). Below this is the range of values (min/max) during the event. The duration of the event is shown below the range value. The vertical axis of the graph is labeled to show the magnitude scale of the graphed data. The horizontal axis is not labeled but automatically scales to accommodate the number of 30-second intervals during the event. The alarm threshold (lower than %SpO<sub>2</sub> alarm limit) is represented by a horizontal dotted line across the graph. The first data point is always the alarm threshold.

Events are displayed one at a time, one per graph. Graphs are displayed in chronological sequence with the most recent event shown first when accessing the graphical *OxiMAX* sensor event display. The user can move between events by using the two left-most softkeys which are labeled with left- and right-facing arrow icons, respectively. At the beginning of an event sequence, event 1 of 2 events, the left-arrow soft key is blank; at the end of a sequence, event 2 of 2 events, the right-arrow soft key is blank.

The ADJUST UP and ADJUST DOWN buttons on the monitor panel can also be used to move through events.

The PRINT softkey allows the user to print the displayed event graph. The BACK softkey takes the user back to the previous TREND/SENSOR sub-menu level.

## Viewing and Printing *OxiMAX* Sensor Event History Data

With the monitor in the normal monitoring mode. You must connect a printer, capable of printing graphs, to the monitor data port connector to print *OxiMAX* sensor event history data.

The monitor protocol must be set to GRAPH to print the in-sensor event history data. Refer to *Printing Monitor Trend Information* on page 79. To view and print in-sensor event history data:

1. Connect an *OxiMAX* sensor containing patient data to the monitor.

2. Press the TREND softkey.



3. Press the SENSOR softkey.



4. Press the GRAPH softkey.

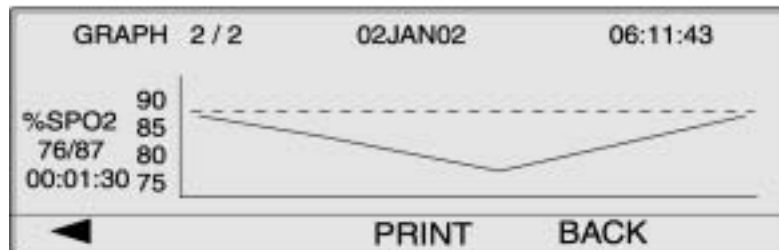

**Note:** Use the left and right arrow softkeys to scroll through the pages of the event graph.

5. Press the PRINT softkey to print the displayed screen.



6. Press the EXIT softkey.



A sequence of %SpO<sub>2</sub> + BPM (saturation plus pulse rate) “dual-view” event graphs are shown below. The dual-view graph is the same as a single graphical event history graph except the graphs are compressed horizontally to allow both %SpO<sub>2</sub> and pulse rate graphs to be shown for the same event.

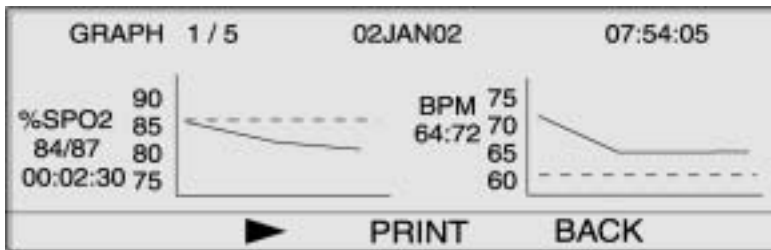
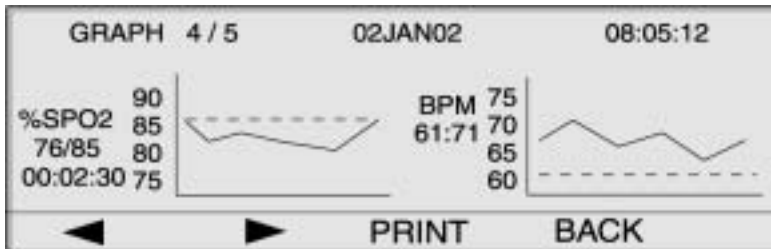
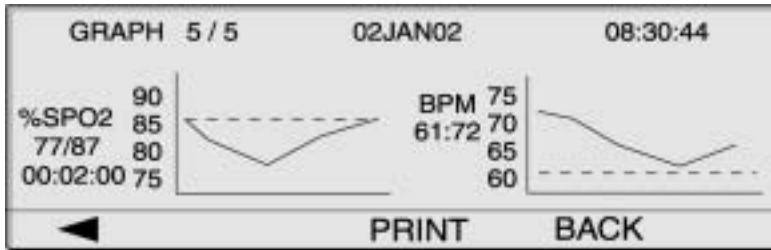

## OXIMAX Sensor Tabular Event Data

The *OXIMAX* sensor tabular event data is a listing of all events recorded on the *OXIMAX* sensor's memory chip.

| SUMMARY |       |       |          |       |       |
|---------|-------|-------|----------|-------|-------|
| #       | DATE  | START | DUR      | %SPO2 | BPM   |
| 4       | 02JAN | 11:07 | 00:10:30 | 76/83 | 60/64 |
| 3       | 02JAN | 10:30 | 00:06:30 | 79/84 | 57/64 |
| 2       | 02JAN | 09:57 | 00:02:00 | 82/84 | 59/63 |
| 1       | 02JAN | 09:46 | 00:05:30 | 75/82 | 56/61 |
|         |       |       | ▶        | PRINT | BACK  |

| SUMMARY |       |       |          |       |       |
|---------|-------|-------|----------|-------|-------|
| #       | DATE  | START | DUR      | %SPO2 | BPM   |
| 100     | 02JAN | 13:55 | 00:03:00 | 75/80 | 63/70 |
| 99      | 02JAN | 11:07 | 00:10:30 | 76/83 | 60/64 |
| 98      | 02JAN | 10:30 | 00:06:30 | 79/84 | 57/64 |
| 97      | 02JAN | 00:02 | 00:02:00 | 82/84 | 59/63 |
| ▲       | ▼     |       |          | PRINT | BACK  |

The table title shows in the upper left corner. Below the table title is a six-column table with left-to-right column headings of event number (#), date (DATE), event start time (START), event duration (DUR), %SPO<sub>2</sub> minimum and maximum values during the event (%SPO<sub>2</sub>), and pulse rate minimum and maximum values during the event (BPM).

Event data are listed in chronological order with the most recent event shown first, at the top of the list, when the tabular Event Summary display is first accessed. Four events can be displayed simultaneously; the table must be scrolled to view additional events. The user can move to the next screen view of the table, the next three events (the previously displayed bottom or top event is retained as the fourth event for context when a table is scrolled), using the two left-most softkeys which are labeled with left- and right-facing arrow icons, respectively. At the beginning of an event sequence, Event 1 of 5 events, the left-arrow soft key is blank; at the end of a sequence,

Event 5 of 5 events, the right-arrow soft key is blank, indicating you have reached the beginning or end of the table.

The ADJUST UP and ADJUST DOWN buttons on the monitor panel can be used to move through the Event Summary table line by line.

The PRINT softkey allows the user to print the displayed event graph.

The BACK softkey takes the user back to the previous TREND/SENSOR sub-menu level.

### Viewing and Printing In-Sensor Tabular Event History Data

The monitor should be in the normal monitoring mode.

To view and print in-sensor tabular event history data:

- TREND** 1. Press the TREND softkey.



- SENSOR** 2. Press the SENSOR softkey.



- TABLE** 3. Press the TABLE softkey.



| SUMMARY |       |       |          |       |       |
|---------|-------|-------|----------|-------|-------|
| #       | DATE  | START | DUR      | %SPO2 | BPM   |
| 100     | 02JAN | 13:55 | 00:03:00 | 75/80 | 63/70 |
| 99      | 02JAN | 11:07 | 00:10:30 | 76/83 | 60/64 |
| 98      | 02JAN | 10:30 | 00:06:30 | 79/84 | 57/64 |
| 97      | 02JAN | 00:02 | 00:02:00 | 82/84 | 59/63 |
|         |       | ▲     | ▼        | PRINT | BACK  |

- PRINT** 4. Press the PRINT softkey to print the data.



**BACK**



5. Press the **BACK** softkey.





## Printing Monitor Trend Information

Trend information (monitor and in-sensor event history) may be sent to a personal computer or to a serial printer.

**Note:** The protocol settings must be set to ASCII MODE for printing text data or GRAPH MODE for printing graphical data.

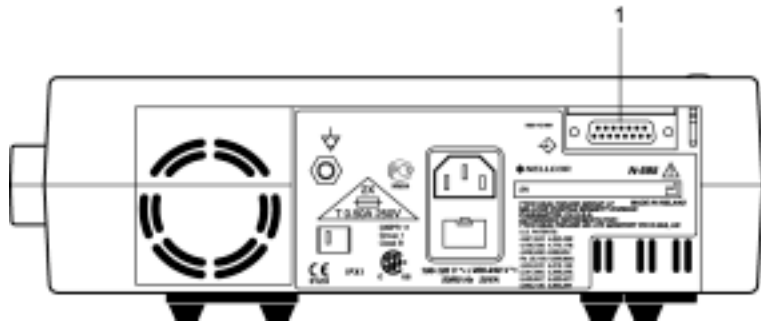

1. Data Port Connector

With the monitor in the normal monitoring mode:

1. Connect the serial printer to the monitor's DATA PORT connector (1), using Nellcor printer cable part number 036341.
2. Turn on the printer.

3. Press the SETUP softkey.



4. Press the NEXT softkey.



**NEXT** 5. Press the NEXT softkey.



**COMM** 6. Press the COMM softkey.



7. Set the BAUD rate to the appropriate number using the ADJUST UP button.

**SELECT** 8. Press the SELECT softkey to select PROTOCOL.



9. Set the PROTOCOL to ASCII for text printing or GRAPH for graph printing using the ADJUST UP button.

**EXIT** 10. Press the EXIT softkey.



**TREND** 11. Press the TREND softkey.



**MONITR** 12. Press the MONITR softkey for monitor trend printing or press the



**SENSOR**



SENSOR softkey for in-sensor event history data printing.

NEXT



13. Press the NEXT softkey.

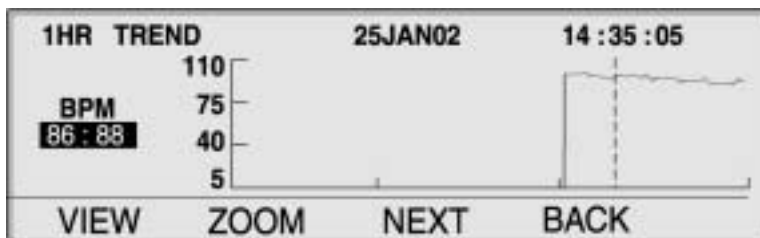

PRINT



14. Press the PRINT softkey.

ASCII printout:

```

N-595 VERSION 1.0.0.0 TREND SpO2 Limit: 85-100% PR Limit: 40-170BPM
      ADULT OSAT-S SPO2 RESP MODE: NORMAL
TIME          %SpO2 BPM PA STATUS
12-JAN-02 14:00:05 100 120 150
12-JAN-02 14:00:09 100 121 154
12-JAN-02 14:00:13 100 120 150
Output Complete
    
```

GRAPH printout:

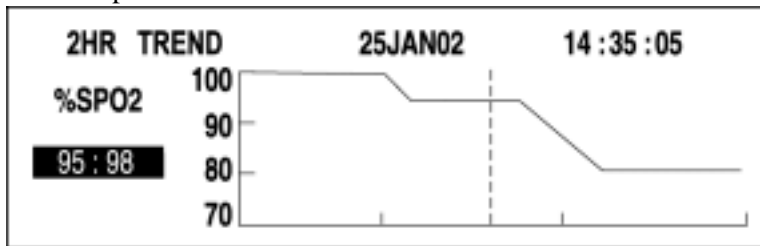

## Monitor Trend Data in ASCII Mode

Refer to *Printing Monitor Trend Information* on page 79 for the procedure to print trend information.

The format of data displayed when a trend printout is shown in Figure 3. “TREND” is displayed in the top row.

Readings are displayed in 2- or 4-second intervals depending on the response mode selected. The values on each row are an average of the response mode selected period.

At the end of the printout an “Output Complete” line indicates that the transmission was successful. If the “Output Complete” line is not present, a corruption of the data may have been detected and the data should be ignored.

|                 |                 |        |   |     |        |
|-----------------|-----------------|--------|---|-----|--------|
| N-595           | VERSION 1.0.0.0 | TREND  | SpO2 Limit: 85-100% PR Limit: 40-170BPM |     |        |
|                 | ADULT           | OSAT-S | SPO2 RESP MODE: NORMAL                  |     |        |
| TIME            |                 | %SpO2  | BPM                                     | PA  | STATUS |
| 12-JAN-02       | 14:00:05        | 100    | 120                                     | 150 |        |
| 12-JAN-02       | 14:00:09        | 100    | 121                                     | 154 |        |
| 12-JAN-02       | 14:00:13        | 100    | 120                                     | 150 |        |
| Output Complete |                 |        |   |     |        |

**Figure 3: ASCII Mode Printout**

Once a trend printout has begun, it cannot be aborted without turning off the N-595 or the printer.

---

## Trend Data in Graph Mode

Refer to *Printing Monitor Trend Information* on page 79 for the procedure to print trend information. See Figure 4 on page 83.

The graph mode disables all printout functions except trend data. Graph mode trend printouts are formatted for a Seiko DPU-414 and Okidata 320 serial printer.

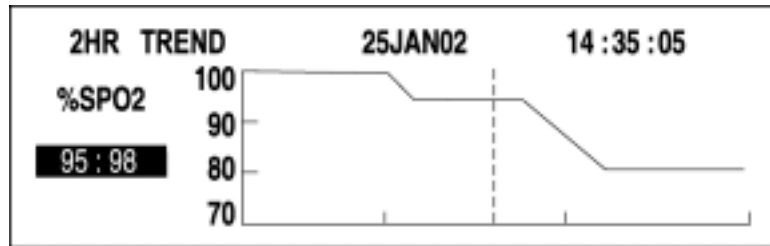

Figure 4: Graph Mode Printout

## Real-Time Display/Printout Format

Real-time data is continuously sent to the data port on the back of the N-595. Patient data can be obtained through the data port by connecting the monitor data port to a PC or serial printer. When a real-time printout or display is being transmitted to a printer or PC, a new line of data is displayed every 2 seconds. Column headings are displayed or printed after every 25 lines, or if one of the values in the column heading changes. Readings are displayed at 4-second intervals if the SpO<sub>2</sub> response mode is set to normal and at 2-second intervals when the SpO<sub>2</sub> response mode is set to fast.

Data cannot be obtained if the N-595 is operating on battery power.

**Note:** If the data output stops transmitting, turn the power off and back on again or, if the monitor is connected to a PC, send an XON (Ctrl-q) command to reset the monitor.

An example of a real-time output is shown in Figure 5 on page 84.

Using the  
N-595

| N-595 VERSION 1.0.0.0 CRC: XXXX SpO2 Limit: 85-100% PR Limit: 40-170BPM |          |        |                        |     |        |       |
|---|----------|--------|------------------------|-----|--------|-------|
| ADULT   |          | OSAT-S | SPO2 RESP MODE: NORMAL |     |        |       |
| TIME  |          | %SpO2  | BPM                    | PA  | Status |       |
| 12-JAN-02   | 14:00:06 | 100    | 120                    | 50  |        |       |
| 12-JAN-02   | 14:00:07 | 100    | 124                    | 50  |        |       |
| 12-JAN-02   | 14:00:09 | 100    | 190*                   | 52  | PH     |       |
| 12-JAN-02   | 14:00:11 | 100    | 190*                   | 50  | PH     |       |
| 12-JAN-02   | 14:00:13 | 100    | 190*                   | 51  | PH     |       |
| 12-JAN-02   | 14:00:15 | 100    | 190*                   | 50  | PH     |       |
| 12-JAN-02   | 14:00:17 | 100    | 190*                   | 50  | PH     |       |
| 12-JAN-02   | 14:00:19 | 100    | 190*                   | 51  | PH     |       |
| 12-JAN-02   | 14:00:21 | 100    | 190*                   | 53  | PH     | LB    |
| 12-JAN-02   | 14:00:23 | 100    | 190*                   | 50  | PH     | LB    |
| 12-JAN-02   | 14:00:25 | 100    | 090*                   | 50  | PH     | LB    |
| 12-JAN-02   | 14:00:27 | ---    | ---                    | --- | SD     | LB    |
| 12-JAN-02   | 14:00:29 | ---    | ---                    | --- | SD     | LB    |
| 12-JAN-02   | 14:00:31 | ---    | ---                    | --- | SD     |       |
| 12-JAN-02   | 14:00:33 | ---    | ---                    | --- | SD     |       |
| 12-JAN-02   | 14:00:35 | ---    | ---                    | --- | SD     |       |
| 12-JAN-02   | 14:00:37 | ---    | ---                    | --- | SD     |       |
| 12-JAN-02   | 14:00:39 | ---    | ---                    | --- | SD     |       |
| 12-JAN-02   | 14:00:41 | ---    | ---                    | --- | SD     |       |
| 12-JAN-02   | 14:00:43 | ---    | ---                    | --- | SD     |       |
| 12-JAN-02   | 14:00:45 | ---    | ---                    | --- | SD     |       |
| 12-JAN-02   | 14:00:47 | ---    | ---                    | --- | SD     |       |
| 12-JAN-02   | 14:00:49 | ---    | ---                    | --- | SD     |       |
| N-595 VERSION 1.0.0.0 CRC: XXXX SpO2 Limit: 85-100% PR Limit: 40-170BPM |          |        |                        |     |        |       |
| ADULT   |          | OSAT-S | SPO2 RESP MODE: NORMAL |     |        |       |
| TIME  |          | %SpO2  | BPM                    | PA  | Status |       |
| 12-JAN-02   | 14:00:51 | ---    | ---                    | --- | SD     |       |
| N-595 VERSION 1.0.0.0 CRC: XXXX SpO2 Limit: 80-100% PR Limit: 40-170BPM |          |        |                        |     |        |       |
| ADULT   |          | OSAT-S | SPO2 RESP MODE: NORMAL |     |        |       |
| TIME  |          | %SpO2  | BPM                    | PA  | Status |       |
| 12-JAN-02   | 14:00:53 | 79*    | 59                     | 50  | SL     | PL LB |
| 12-JAN-02   | 14:00:55 | 79*    | 59                     | 50  | PS SL  | PL LB |

Figure 5: Real-Time Printout

## Column Headings

Every 25<sup>th</sup> line of the data consists of a column heading.

|       |                 |           |                        |                     |
|-------|-----------------|-----------|------------------------|---------------------|
| N-595 | VERSION 1.0.0.0 | CRC: XXXX | SpO2 Limit: 85-100%    | PR Limit: 40-170BPM |
|       | ADULT           | OSAT-S    | SPO2 RESP MODE: NORMAL |                     |
| TIME  | %SpO2           | BPM       | PA                     | Status              |

A column heading is also output whenever a value of the column heading is changed. There are three column-heading lines shown in the printout. Using the top row as the starting point there are 25 lines before the second row of column headings is printed. The third row of column headings was displayed because the operator changed the SpO2 lower alarm limit from 85 percent to 80 percent.

Using the N-595

## Data Source

|       |                 |           |                        |                     |
|-------|-----------------|-----------|------------------------|---------------------|
| N-595 | VERSION 1.0.0.0 | CRC: XXXX | SpO2 Limit: 85-100%    | PR Limit: 40-170BPM |
|       | ADULT           | OSAT-S    | SPO2 RESP MODE: NORMAL |                     |
| TIME  | %SpO2           | BPM       | PA                     | Status              |

Data in the highlighted box above represents the model number of the monitor, in this case the N-595.

## Software Version

|       |                 |           |                        |                     |
|-------|-----------------|-----------|------------------------|---------------------|
| N-595 | VERSION 1.0.0.0 | CRC: XXXX | SpO2 Limit: 85-100%    | PR Limit: 40-170BPM |
|       | ADULT           | OSAT-S    | SPO2 RESP MODE: NORMAL |                     |
| TIME  | %SpO2           | BPM       | PA                     | Status              |

The next data field tells the user the software level (Version 1.0.0.0) and a software verification number (CRC: XXXX). Neither of these numbers should change during normal operation. The numbers may change if the monitor is serviced and receives a software upgrade.

## Alarm Limits

|       |                 |           |                        |                     |
|-------|-----------------|-----------|------------------------|---------------------|
| N-595 | VERSION 1.0.0.0 | CRC: XXXX | SpO2 Limit: 85-100%    | PR Limit: 40-170BPM |
|       | ADULT           | 0SAT-S    | SPO2 RESP MODE: NORMAL |                     |
| TIME  | %SpO2           | BPM       | PA                     | Status              |

The last data field in the top line indicates the upper and the lower alarm limits for %SpO2 and for the pulse rate (PR). In the example above the lower alarm limit for SpO2 is 85% and the upper alarm limit is 100%. Pulse Rate alarm limits are 40 and 170 bpm. The *SatSeconds* alarm limit (0SAT-S) displays the *SatSeconds* alarm setting. In this example *SatSeconds* is set to off.

## Monitor Mode

|       |                 |           |                        |                     |
|-------|-----------------|-----------|------------------------|---------------------|
| N-595 | VERSION 1.0.0.0 | CRC: XXXX | SpO2 Limit: 85-100%    | PR Limit: 40-170BPM |
|       | ADULT           | 0SAT-S    | SPO2 RESP MODE: NORMAL |                     |
| TIME  | %SpO2           | BPM       | PA                     | Status              |

The monitor mode (ADULT or NEONATE) is identified on the printout.

## Response Mode

|       |                 |           |                        |                     |
|-------|-----------------|-----------|------------------------|---------------------|
| N-595 | VERSION 1.0.0.0 | CRC: XXXX | SpO2 Limit: 85-100%    | PR Limit: 40-170BPM |
|       | ADULT           | 0SAT-S    | SPO2 RESP MODE: NORMAL |                     |
| TIME  | %SpO2           | BPM       | PA                     | Status              |

The response mode (NORMAL or FAST) is identified on the printout.



## Data Column Headings

|   |       |        |                        |        |  |
|---|-------|--------|------------------------|--------|--|
| N-595 VERSION 1.0.0.0 CRC: XXXX SpO2 Limit: 85-100% PR Limit: 40-170BPM |       |        |                        |        |  |
| ADULT   |       | OSAT-S | SPO2 RESP MODE: NORMAL |        |  |
| TIME  | %SpO2 | BPM    | PA                     | Status |  |

Actual column headings are in the second row of the column heading line. Patient data presented in the chart, from left to right, is the:

- time the patient data were obtained
- current %SpO2 value
- current Pulse Rate (BPM)
- current Pulse Amplitude (PA)
- operating status of the N-595.

Using the N-595

## Time

|                    |  |       |      |    |        |
|--------------------|--|-------|------|----|--------|
| TIME               |  | %SpO2 | BPM  | PA | Status |
| 12-JAN-02 14:00:05 |  | 100   | 190* | 50 |        |

The Time column represents the N-595 real-time clock.

## Patient Data

|   |       |        |                        |        |  |
|---|-------|--------|------------------------|--------|--|
| N-595 VERSION 1.0.0.0 CRC: XXXX SpO2 Limit: 85-100% PR Limit: 40-170BPM |       |        |                        |        |  |
| ADULT   |       | OSAT-S | SPO2 RESP MODE: NORMAL |        |  |
| TIME  | %SpO2 | BPM    | PA                     | Status |  |
| 12-JAN-02 14:00:05  | 100   | 190*   | 50                     |        |  |

Patient data are highlighted in the display above. Parameter values are displayed directly beneath the heading for each parameter. In this

example the %SpO<sub>2</sub> is 100, and the pulse rate is 190 beats per minute. The “\*” next to the 190 indicates that 190 beats per minute is outside of the alarm limits, indicated in the top row, for pulse rate. If no data for a parameter is available, three dashes (- - -) will be displayed.

PA represents pulse amplitude. The number can range from 0 to 254. There are no alarm parameters for this value. It can be used for trending information as an indication of a change in pulse volume, relative pulse strength, or circulation.

Operating Status

|   |                   |        |                        |        |
|---|-------------------|--------|------------------------|--------|
| N-595 VERSION 1.0.0.0 CRC: XXXX SpO2 Limit: 85-100% PR Limit: 40-170BPM |                   |        |                        |        |
| ADULT   |                   | 0SAT-S | SPO2 RESP MODE: NORMAL |        |
| TIME  | %SpO <sub>2</sub> | BPM    | PA                     | Status |
| 12-JAN-02 14:00:05  | 100               | 165    | 50                     | PH     |

The Status column indicates alarm conditions and operating status of the N-595. In this example, the PH means that the pulse rate upper alarm limit (Pulse High) has been exceeded. A complete listing of the status codes is listed below. As many as four codes can be displayed at one time in the Status column.

| Code | Meaning                      |
|------|------------------------------|
| AO   | Alarm Off                    |
| AS   | Alarm Silence                |
| LB   | Low Battery                  |
| LM   | Loss of Pulse w/ Motion      |
| LP   | Loss of Pulse                |
| MO   | Patient Motion               |
| PH   | Pulse Rate Upper Limit Alarm |
| PL   | Pulse Rate Lower Limit Alarm |
| PS   | Pulse Search                 |

---

| <b>Code</b> | <b>Meaning</b>               |
|-------------|------------------------------|
| <b>SH</b>   | Saturation Upper Limit Alarm |
| <b>SL</b>   | Saturation Lower Limit Alarm |
| <b>SD</b>   | Sensor Disconnect            |
| <b>SO</b>   | Sensor Off                   |

---

**Note:** An *OxiMAX* sensor disconnect will also cause three dashes (- - -) to be displayed in the patient data section of the display or printout.



# Using the Data Port

---

---

## Overview

Patient data can be output through the data port on the back of the N-595 by connecting it to an attached PC or serial printer.

When connecting the N-595 to a printer or PC, verify proper operation before clinical use. Both the N-595 and the printer or PC must be connected to a grounded AC outlet. The N-595 protocol setting must be ASCII.

Any printer or PC connected to the monitor's data port must be certified according to IEC Standard 950. All combinations of equipment must be in compliance with IEC Standard 60601-1-1 systems requirements. Anyone who connects a printer or PC to the data output port configures a medical system and is therefore responsible for ensuring that the system complies with the requirements of system standard IEC Standard 60601-1-1 and the electromagnetic compatibility system standard IEC Standard 60601-1-2.

---

## Connecting to the Data Port

The N-595 data port may be connected to a serial printer or PC by using a cable terminated with an AMP connector (AMP part number 747538-1), ferrule (AMP part number 1-747579-2), and compatible pins (AMP part number 66570-2). The cable should be no more than 25 feet (7.6 meters) in length. The external ITE (Information Technology Equipment) device must be certified to UL-1950 or IEC-60950.

The cable used must have a braided shield providing 100% coverage, such as a Belden cable (Belden part number 9609) or equivalent. The shield must have a 360-degree connection to the metal shell on the

N-595's DB-15 connector and to the connector on the PC or serial printer. Do not create sharp bends in the cable, as this may tear or break the shielding.

No hardware flow control is used. However, in the ASCII mode XON/XOFF flow control is supported.

---

## Data Port Pinouts

The pinouts for the data port are listed in Table 5 on page 92.

**Table 5: Data Port Pinouts**

| <b>Pin</b> | <b>Signal Name</b>                                |
|------------|---|
| 1          | RXD+ (RS-422 [+] input)                           |
| 2          | RXD_232 (RS-232 input)                            |
| 3          | TXD_(RS-232 output)                               |
| 4          | TXD+ (RS-422 [+] output)                          |
| 5          | Signal Ground (isolated from Earth Ground)        |
| 6          | AN_SpO2 (analog saturation output)                |
| 7          | NC_NO (relay closure nurse call, normally open)   |
| 8          | NC_NC (relay closure nurse call, normally closed) |
| 9          | RxD- (RS_422 [-] input)                           |
| 10         | Signal Ground (isolated from Earth Ground)        |
| 11         | Nurse Call (RS-232-level-output)                  |
| 12         | TxD- (RS-422 [-] output)                          |
| 13         | AN_PULSE (analog pulse rate output)               |
| 14         | AN_PLETH (analog pleth waveform output)           |
| 15         | NC_COM (relay closure nurse call, common lead)    |

---

---

TxD represents the Transmit Data line, and RxD is the Receive Data line.

The pin layouts (as viewed from the rear panel of the N-595) are illustrated in Figure 6 on page 93. The conductive shell is connected to earth ground when connected to a PC or printer.



**Figure 6: Data Port Pin Layout**

Pins 2, 3, and 5 provide data in RS-232 format.

Pins 1, 4, 9, and 12 provide data in RS-422 format. TxD+ and TxD- are the differential transmit data pair. RxD+ and RxD- are the differential receive pair.

## Data Port Setup

Use the Data Port Setup display to set the baud rate and the protocol of the data port on the N-595.

The Data Port Setup display is accessed by pressing the COMM softkey on the Setup menu.

With the monitor in the normal monitoring mode:

- SETUP** 1. Press the SETUP softkey.



- NEXT** 2. Press the NEXT softkey.



- NEXT** 3. Press the NEXT softkey.





4. Press the COMM softkey.

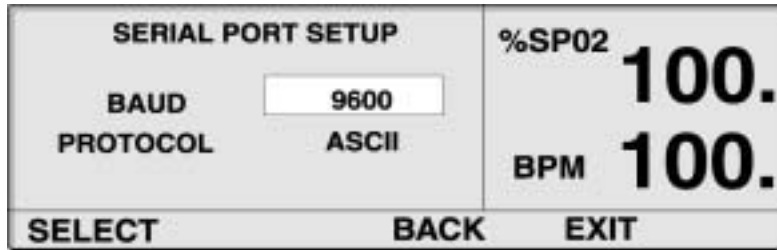

5. Press the ADJUST UP or ADJUST DOWN buttons to select the desired baud rate.



6. Press the SELECT softkey to select protocol.



7. Press the ADJUST UP or ADJUST DOWN buttons to select the desired protocol. The available protocols are:

- ASCII
- CLINICAL
- GRAPH
- OXINET
- AGILENT (HP Agilent)
- SPACELBS (Spacelabs)
- MARQ (GE Marquette)
- DATEX (Datex-Ohmeda)



8. Press the EXIT softkey.



---

## Using the Nurse Call Interface



---

**WARNING:** The nurse call feature should not be used as the primary source of alarm notification. The audible and visual alarms of the pulse oximeter, used in conjunction with clinical signs and symptoms, are the primary sources for notifying medical personnel that an alarm condition exists.

---



---

**WARNING:** The nurse call feature is not functional whenever the pulse oximeter alarms are silenced.

---

The nurse call feature of the N-595 monitor is operational when the monitor is powered by AC power or battery power. The nurse call feature of the N-595 works in conjunction with the nurse call system of your institution when the monitor sounds an audible alarm. It is accessed through the data port pins 7, 8, 10, 11, or 15 as indicated in Table 5 on page 92.

The N-595 provides two different types of nurse call interfaces: an RS-232 level and relay closure. The RS-232 level nurse call function operates when the monitor is connected to AC power or on battery. The relay-based nurse call function is available when the monitor is operating either on AC power or on battery power.

The remote location is signaled anytime there is an audible alarm. If the audible alarm has been turned off or silenced, the nurse call function is also turned off.

Pin 11 on the data port is the RS-232 level nurse call signal and pin 5 or 10 is ground (see Table 5 on page 92). When there is no alarm condition, the voltage between pins 10 and 11 is -5 to -12 VDC. Whenever the monitor is in an alarm condition, the output between pins 10 and 11 is +5 to +12 VDC.





Pins 7 and 15 provide a relay that closes when an alarm is sounding on the monitor. Pins 8 and 15 provide a relay that opens when an alarm is sounding. Pin 15 is a common lead for both relays.

The nurse call function needs to be tested after it has been set up in your facility. The nurse call feature should be tested whenever setting up the N-595 pulse oximeter in a location that uses nurse call. If an attached *OxiMAX* sensor is not connected to a patient, the monitor display reads zeros and the monitor remains in the Pulse Search Mode for 5 seconds, then the monitor displays “--- “ (3 dashes) in the %SpO2 and pulse rate display. One way to test the nurse call function is to create an alarm condition (for example, sensor disconnect) and verify that your facility's nurse call system is activated.

### Setting Nurse Call RS-232 Polarity

The nurse call polarity can be set to a positive signal (NORM +) on a monitor alarm condition or a negative signal (NORM -) on a monitor alarm condition.

With the monitor in the normal monitoring mode:

- SETUP** 1. Press the SETUP softkey.  

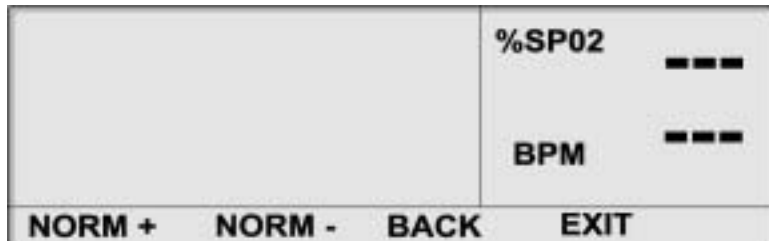
- NEXT** 2. Press the NEXT softkey.  

- NEXT** 3. Press the NEXT softkey.  

- NCALL** 4. Press the NCALL softkey.  



**NORM +** 5. Press the NORM + softkey.  

or

**NORM -** 6. Press the NORM - softkey.  

**EXIT** 7. Press the EXIT softkey.  

## Setting Nurse Call Relays Normally Open/Closed

Data port pins 7 and 15 provide a relay that closes when an alarm is sounding on the monitor. Pins 8 and 15 provide a relay that opens when an alarm is sounding. Pin 15 is a common lead for both relays. The relay operates whether the monitor is operating on AC power or battery.

## Calculating the Analog Voltage Output





The N-595 data port provides analog voltage outputs between pins 6, 13, 14, and ground (pin 10), which can be used to calibrate instruments such as a chart recorder. The voltage represents a specific measured parameter's current value. The voltage differential varies proportionally from 0 to 1 volt as the pin's parameter varies over its full range of values, as indicated in Table 6 on page 97.

**Table 6: Analog Pinouts**

| Pin | Parameter      | Parameter Range |
|-----|----------------|-----------------|
| 6   | %SpO2          | 0 - 100%        |
| 13  | Pulse Rate     | 0 - 250 bpm     |
| 14  | Pleth Waveform | 0 - 255         |

For example, as the current value of %SpO<sub>2</sub> varies from 0 to 100%, the voltage from pin 6 to ground (pin 10) varies from 0 to 1 volt. A voltage of 0.94 volts indicates a current %SpO<sub>2</sub> value of 94.

The analog function can be accessed from the main menu:

- SETUP** 1. Press the SETUP softkey.  

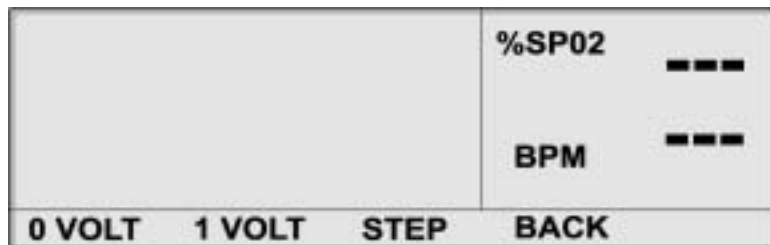
- NEXT** 2. Press the NEXT softkey.  

- NEXT** 3. Press the NEXT softkey.  

- NEXT** 4. Press the NEXT softkey.  

- ANALOG** 5. Press the ANALOG softkey.  



Selecting the 0 VOLT or 1 VOLT softkey causes that voltage to appear at pins 6, 13, or 14 as referenced to ground pins 5 and 10.

Selecting the STEP softkey causes the voltage to increase from 0 to 1 volt at 1/10<sup>th</sup>-volt increments, with each step lasting at least 1 second.

Qualified service personnel, using the procedure described in the N-595 service manual, can perform calibration of the attached device.



**WARNING:** The sensor extrapolates from the date and time provided by the N-595 when recording the sensor event record to the sensor. The accuracy of the date/time is the responsibility of the N-595. It is recommended that the N-595 user set the time/date to the correct value before a sensor event record-enabled sensor is connected, and that this date/time not be changed while the sensor remains connected. Since a sensor with sensor event record data can be transported from one monitor to another, having discrepancies in the date/time between monitors and the sensor event record data will affect the order the sensor event record data appears. To eliminate this possible problem, all monitors within an institution should be set to the same time.

---

---

## OXIMAX Sensor Event Record Data

The N-595 records a patient's *OXIMAX* sensor %SpO<sub>2</sub> event history from the *OXIMAX* sensor's memory chip, allowing a patient's event history to travel with the patient as the patient moves throughout the hospital. This allows caregivers to assess whether the patient had a bad event during transport or in the previous area of care. This feature is only available with adhesive single-patient-use *OXIMAX* sensors. Single-patient-use *OXIMAX* sensors are intended for single-patient use only; recorded %SpO<sub>2</sub> event history data does not distinguish between events that have been collected from multiple patients.

---

## Selecting an *OXIMAX* Sensor



**WARNING:** Before use, carefully read the *OXIMAX* sensor directions for use, including all warnings, cautions, and instructions.

---



**WARNING:** Do not use a damaged *OXIMAX* sensor or pulse oximetry cable. Do not use an *OXIMAX* sensor with exposed optical components.

---



**WARNING:** Use only Nellcor-approved *OXIMAX* sensors and pulse oximetry cables with this pulse oximeter. Other sensors or pulse oximetry cables may cause improper N-595 performance.

---



**WARNING:** Do not attach any cable to the *OXIMAX* sensor port connector that is intended for computer use.

---



**WARNING:** Tissue damage can be caused by incorrect application or duration of use of an SpO<sub>2</sub> *OXIMAX* sensor. Inspect the *OXIMAX* sensor site periodically as directed in the *OXIMAX* sensor directions for use.

---



**WARNING:** Pulse oximetry readings and pulse signal can be affected by certain ambient environmental conditions, *OXIMAX* sensor application errors, and certain patient conditions.

---



**WARNING:** Do not immerse or wet the *OXIMAX* sensor.

---



**WARNING:** Do not lift the pulse oximeter by the pulse oximetry cable or power cord because the cable or cord could disconnect from the pulse oximeter, causing the pulse oximeter to drop on the patient.

---



**Caution:** The *OXIMAX* sensor disconnect error message and associated alarm indicate that the *OXIMAX* sensor is either disconnected or the wiring is faulty. The user should check the *OXIMAX* sensor connection and, if necessary, replace the *OXIMAX* sensor, pulse oximetry cable, or both.

**Note:** Physiological conditions, medical procedures, or external agents that may interfere with the pulse oximeter's ability to detect and display measurements include dysfunctional hemoglobin, arterial dyes, low perfusion, dark pigment, and externally applied coloring agents such as nail polish, dye, or pigmented cream.

For a complete and up-to-date listing of all *OXIMAX* sensors applicable to the N-595, refer to the Sensor Accuracy Grid posted on the Internet at:

[http://www.mallinckrodt.com/respiratory/resp/Serv\\_Supp/ProductManuals.html](http://www.mallinckrodt.com/respiratory/resp/Serv_Supp/ProductManuals.html)

When selecting an *OXIMAX* sensor, consider the patient's weight and activity level, the adequacy of perfusion, and the available *OXIMAX* sensor sites, the need for sterility, and the anticipated duration of monitoring. For more information refer to Table 7 on page 101 or contact your local Nellcor representative. Refer to *OXIMAX Sensor Performance Considerations* on page 113, for more information on *OXIMAX* sensor performance.

**Table 7: Nellcor *OXIMAX* Sensor Models and Patient Sizes**

| <i>OXIMAX</i> Sensor                                      | Model    | Patient Size |
|---|----------|--------------|
| <i>OXIMAX</i> MAX-FAST adhesive reflectance oxygen sensor | MAX-FAST | >10 kg       |

**Table 7: Nellcor *OxiMAX* Sensor Models and Patient Sizes**

| <i>OxiMAX</i> Sensor   | Model   | Patient Size |
|--|---------|--------------|
| <i>OxiMAX</i> oxygen sensor (Sterile, single-use only)                               | MAX-N   | <3 or >40 kg |
|  | MAX-I   | 3 to 20 kg   |
|  | MAX-P   | 10 to 50 kg  |
|  | MAX-A   | >30 kg       |
|  | MAX-AL  | >30 kg       |
|  | MAX-R   | >50 kg       |
| <i>OxiMAX Durasensor</i> <sup>®</sup> oxygen sensor (Reusable, nonsterile)           | DS-100A | >40 kg       |
| <i>OxiMAX Oxiband</i> <sup>®</sup> oxygen sensor (Reusable with adhesive nonsterile) | OXI-A/N | <3 or >40 kg |
|  | OXI-P/I | 3 to 40 kg   |
| <i>OxiMAX OxiCliq</i> <sup>®</sup> oxygen sensors (Sterile, single-use only)         | P       | 10 to 50 kg  |
|  | N       | <3 or >40 kg |
|  | I       | 3 to 20 kg   |
|  | A       | > 30 kg      |
| <i>OxiMAX Dura-Y</i> <sup>®</sup> multisite oxygen sensor (Reusable, nonsterile)     | D-YS    | >1 kg        |
| For use with the Dura-Y sensor:  |         |              |
| Ear clip (Reusable, nonsterile)  | D-YSE   | >30 kg       |
| <i>Pedi-Check</i> <sup>™</sup> pediatric spot-check clip (Reusable, nonsterile)      | D-YSPD  | 3 to 40 kg   |

The pulse oximetry cable DOC-10 connects the N-595 pulse oximeter with the patient *OxiMAX* sensor.



## OxIMAX Sensor Features

*OxIMAX* sensor features are different for *OxIMAX* sensors at a different revision level and by *OxIMAX* sensor type (adhesive, recycled, and reusable). The revision level of an *OxIMAX* sensor is located on the *OxIMAX* sensor plug.

**Table 8: *OxIMAX* Sensor Features**

| Feature                           | Adhesive Sensors | Recycled Sensors | Reusable Sensors |        |
|-----------------------------------|------------------|------------------|------------------|--------|
|                                   | Rev. B           | Rev. B           | Rev. A           | Rev. B |
| <i>OxIMAX</i> Sensor Event Record | Yes              | No               | No               | No     |
| Sensor Messages                   | Yes              | Yes              | No               | Yes    |
| Sensor ID Message                 | Yes              | Yes              | Yes              | Yes    |

## Biocompatibility Testing

Biocompatibility testing has been conducted on Nellcor *OxIMAX* sensors in compliance with ISO 10993-1, Biological Evaluation of Medical Devices, Part 1: Evaluation and Testing. The *OxIMAX* sensors have passed the recommended biocompatibility testing and are therefore in compliance with ISO 10993-1.

## Optional Accessories

Several mounting configurations, a carrying case, and a utility basket are offered with the N-595. Contact Nellcor's Technical Services Department or your local Nellcor representative for information about these accessories.

- GCX Mounting Plate. See Figure 7 on page 105.

- GCX Poly-mount (vertical wall mount with 19-inch channel). See Figure 8 on page 106.
- GCX Poly-mount (horizontal wall mount with rail adapter). See Figure 9 on page 107.
- GCX Poly-mount Roll Stand. See Figure 10 on page 108.
- GCX Utility Basket. See Figure 11 on page 109.
- Soft-Sided Carrying Case. See Figure 12 on page 110.

Accessories for the N-595 are also listed on the Internet at:

[http://www.mallinckrodt.com/respiratory/resp/Serv\\_Supp/Apartweb/main/PartAcceMenu.html](http://www.mallinckrodt.com/respiratory/resp/Serv_Supp/Apartweb/main/PartAcceMenu.html)

## GCX Mounting Plate

An optional mounting plate is available from Nellcor for the N-595. This mounting plate fits standard, commercially available GCX mount brackets, and is used to securely mount the N-595 to a wall bracket or a roll stand.

The mounting plate attaches to the bottom of the N-595 pulse oximeter as shown in Figure 7 on page 105. For further instructions regarding connecting the mounting plate to GCX brackets, refer to the illustrated directions for use included with the GCX mounting plate.

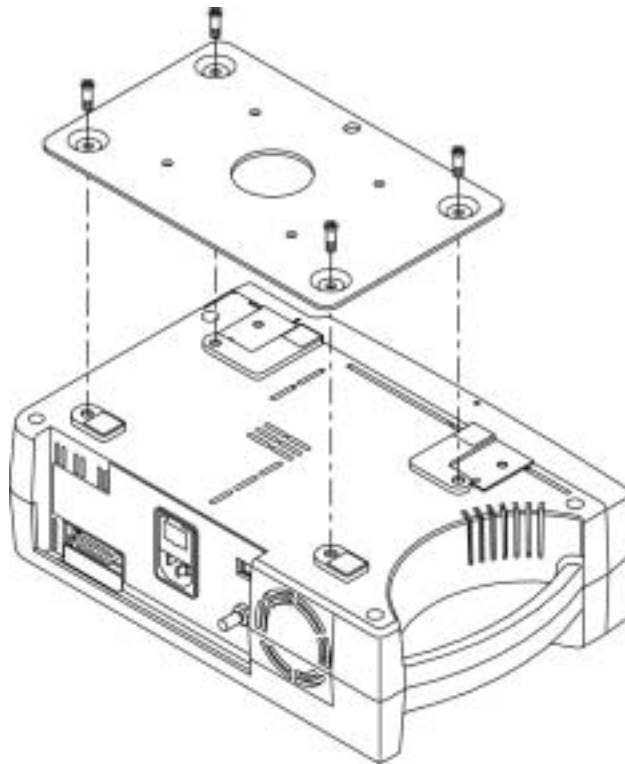
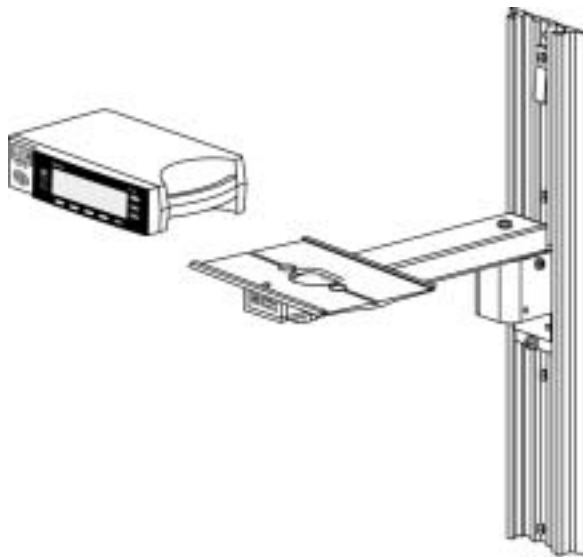

**Figure 7: GCX Mounting Plate**

### GCX Poly-Mount (vertical wall mount with 19-inch channel)

An optional vertical wall mount with 19-inch channel is available from Nellcor for the N-595 pulse oximeter.

The vertical wall mount with 19-inch channel attaches to the N-595 pulse oximeter GCX mounting plate as shown in Figure 8 on page 106. For further instructions regarding connecting the vertical wall mount with 19-inch channel, refer to the illustrated directions for use included with the vertical wall mount with 19-inch channel.

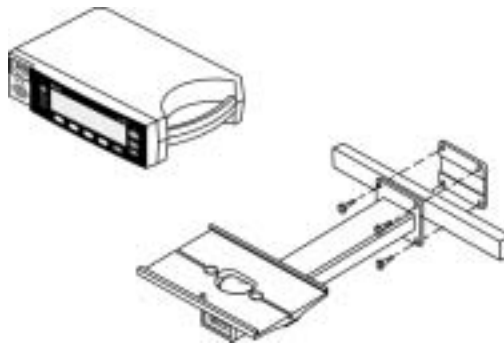

**Figure 8: GCX Poly-Mount (vertical wall mount with 19-inch channel)**

## GCX Poly-Mount (horizontal wall mount with rail adapter)

An optional horizontal wall mount with rail adapter is available from Nellcor for the N-595 pulse oximeter.

The horizontal wall mount with rail adapter attaches to the N-595 pulse oximeter GCX mounting plate as shown in Figure 9 on page 107. For further instructions regarding connecting the horizontal wall mount with rail adapter, refer to the illustrated directions for use included with the horizontal wall mount with rail adapter.

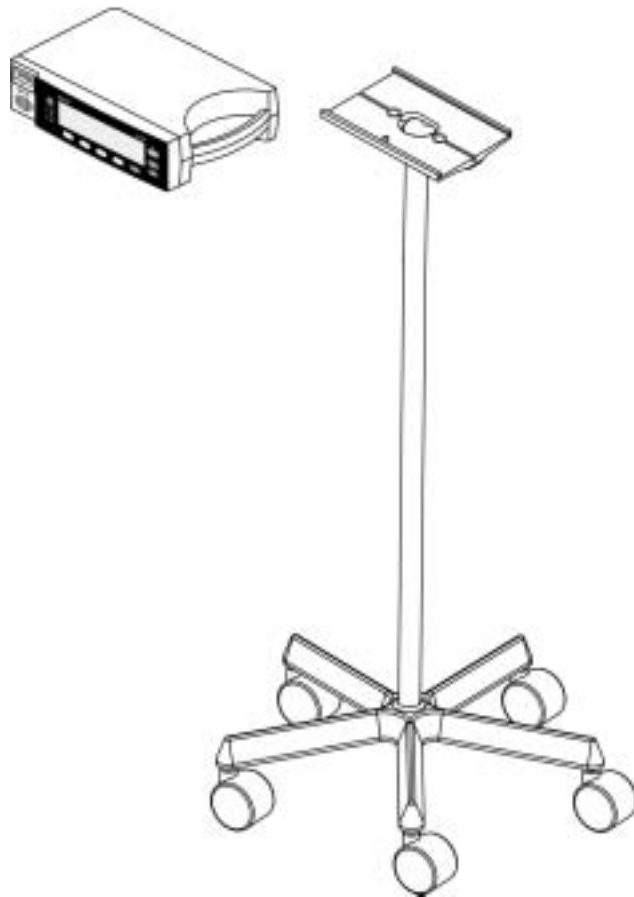

**Figure 9: GCX Poly-mount (horizontal wall mount with rail adapter)**

## GCX Poly-Mount Roll Stand

An optional GCX poly-mount roll stand is available from Nellcor for the N-595 pulse oximeter.

The GCX poly-mount roll stand attaches to the N-595 GCX mounting plate as shown in Figure 10 on page 108. For further instructions regarding connecting the GCX poly-mount roll stand, refer to the illustrated directions for use included with the GCX poly-mount roll stand.



**Figure 10: GCX Poly-mount Roll Stand**

---

## GCX Utility Basket

An optional GCX utility basket is available from Nellcor for the N-595 pulse oximeter. See Figure 11 on page 109.

The GCX utility basket attaches to the roll stand poly-mount. For further instructions regarding connecting the GCX utility basket, refer to the illustrated directions for use included with the GCX utility basket.



**Figure 11: GCX Utility Basket**

---

## Soft-Sided Carrying Case

An optional soft-sided carrying case is available from Nellcor for the N-595 pulse oximeter. See Figure 12 on page 110. The padded carrying case protects the N-595 while transporting the monitor. The carrying case contains two pockets for *OxiMAX* sensors, cables, and operator's manual.



**Figure 12: Soft-Sided Carrying Case**



# Performance Considerations

---



**WARNING:** Pulse oximetry readings and pulse signals can be affected by certain ambient environmental conditions, *OXIMAX* sensor application errors, and certain patient conditions. See the appropriate sections of the manual for specific safety information:

---

- *Safety Information* on page 1
- *OXIMAX Sensors and Accessories* on page 99
- *Performance Considerations* on page 111

---

## Performance Verification

The performance of the N-595 can be verified by following the procedures outlined in the Performance Verification section of the N-595 service manual. Qualified service personnel should perform these procedures before using the monitor for the first time in a clinical setting.

---

## N-595 Monitor Performance Considerations

Certain patient conditions can affect the measurements of the N-595 and cause the loss of the pulse signal.

Inaccurate measurements can be caused by:

- prolonged and/or excessive patient movement
- venous pulsations

- intravascular dyes, such as indocyanine green or methylene blue
- externally applied coloring agents (nail polish, dye, pigmented cream)
- defibrillation

---

## Dysfunctional Hemoglobins

Dysfunctional hemoglobins such as carboxyhemoglobin, methemoglobin, and sulphemoglobin are unable to carry oxygen. SpO<sub>2</sub> readings may appear normal; however, a patient may be hypoxic because less hemoglobin is available to carry oxygen. Further assessment beyond pulse oximetry is recommended.

---

## Anemia

Anemia causes decreased arterial oxygen content. Although SpO<sub>2</sub> readings may appear normal, an anemic patient may be hypoxic. Correcting anemia can improve arterial oxygen content. The monitor may fail to provide an SpO<sub>2</sub> if hemoglobin levels fall below 5 gm/dl.

---

## Saturation

The N-595 will display saturation levels between 1 and 100%.

---

## Pulse Rates

The N-595 will only display pulse rates between 20 and 250 beats per minute. Detected pulse rates above 250 bpm are displayed as 250. Detected pulse rates below 20 are displayed as 0.

---

## **OxIMAX Sensor Performance Considerations**

---



**WARNING: Pulse oximetry readings and pulse signal can be affected by certain ambient conditions, *OxIMAX* sensor application errors, and certain patient conditions.**

---



**WARNING: Tissue damage can be caused by incorrect application or inappropriate duration of use of an SpO<sub>2</sub> *OxIMAX* sensor. Inspect the *OxIMAX* sensor site as directed in the *OxIMAX* sensor directions for use.**

---



**Warning: Use only Nellcor-approved *OxIMAX* sensors and pulse oximetry cables.**

---

Inaccurate measurements can be caused by:

- incorrect application of the *OxIMAX* sensor
- placement of the *OxIMAX* sensor on an extremity with a blood pressure cuff, arterial catheter, or intravascular line
- ambient light
- prolonged and/or excessive patient movement
- intravascular dyes or externally applied coloring, such as nail polish or pigmented cream
- failure to cover the *OxIMAX* sensor site with opaque material in high ambient light conditions

Loss-of-pulse signal can occur for the following reasons:

- the *OxIMAX* sensor is applied too tightly

- a blood pressure cuff is inflated on the same extremity as the one with the *OxiMAX* sensor attached
- there is arterial occlusion proximal to the *OxiMAX* sensor
- poor peripheral perfusion

Select an appropriate *OxiMAX* sensor, apply it as directed, and observe all warnings and cautions presented in the directions for use accompanying the *OxiMAX* sensor. Clean and remove any substances such as nail polish from the application site. Periodically check to ensure that the *OxiMAX* sensor remains properly positioned on the patient.

High ambient light sources such as surgical lights (especially those with a xenon light source), bilirubin lamps, fluorescent lights, infrared heating lamps, and direct sunlight can interfere with the performance of an SpO<sub>2</sub> *OxiMAX* sensor. To prevent interference from ambient light, ensure that the *OxiMAX* sensor is properly applied, and cover the *OxiMAX* sensor site with opaque material.



---

**WARNING: Failure to cover the *OxiMAX* sensor site with opaque material in high ambient light conditions may result in inaccurate measurements.**

---

If patient movement presents a problem, try one or more of the following remedies to correct the problem.

- verify that the *OxiMAX* sensor is properly and securely applied
- move the *OxiMAX* sensor to a less active site
- use an adhesive *OxiMAX* sensor that tolerates some patient motion
- use a new *OxiMAX* sensor with fresh adhesive backing

If poor perfusion affects performance, consider using the MAX-R *OxiMAX* sensor; it obtains measurements from the nasal septal anterior ethmoid artery, an artery supplied by the internal carotid. This *OxiMAX* sensor may obtain measurements when peripheral perfusion is relatively poor.



# Troubleshooting

---



**WARNING:** If you are uncertain about the accuracy of any measurement, check the patient's vital signs by alternate means; then make sure the pulse oximeter is functioning correctly.

---



**WARNING:** The cover should be removed only by qualified service personnel. There are no user-serviceable parts inside.

---



**Caution:** Do not spray, pour, or spill any liquid on the N-595, its accessories, connectors, switches, or openings in the chassis.

---

## Error Codes

When the N-595 detects an error condition, it may display “EEE” followed by an error code.

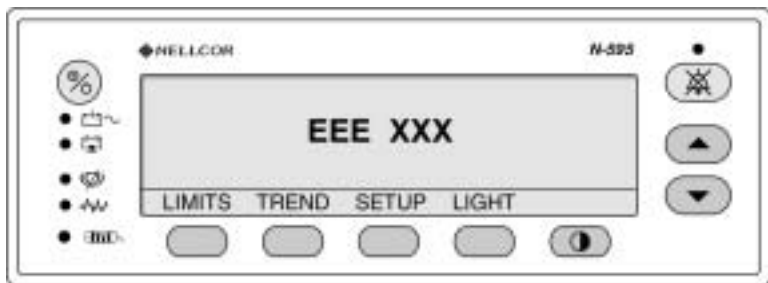

**Note:** The “XXX” indicates that the error code number may contain up to three digits.

When an error code (other than the ones listed in Table 9 on page 118) is displayed, turn the instrument off and back on again. If the error code reappears, record it and notify service personnel.

Table 9 on page 118 lists the error codes and possible causes. When this occurs, the unit will stop monitoring, remove all information from the screen and display the message “EEE XXX,” and sound a low priority alarm. Cycling the power clears these errors.

**Table 9: Error Codes**

| <b>Error Code</b> | <b>Error Message</b> | <b>Action</b>   |
|-------------------|----------------------|---|
| 80                | DEFAULTS LOST        | The current power-on default settings have been lost and returned to factory defaults. Qualified service personnel can use the service manual to restore the desired power-on default settings.   |
| 81                | SETTINGS LOST        | The current settings (for example, alarm limits, alarm and pulse beep volumes, alarm silence duration) have been lost and returned to power-on defaults. Turn the monitor off and back on again. If it is necessary to have settings different from the power-on default settings, turn the monitor off and back on again, and reenter the desired settings.  |
| 82                | CLOCK SETTING LOST   | The date and time settings have been lost. Reenter the date and time.   |
| 530               | LOW BATTERY          | <p>The battery is discharged to a critically low level.</p> <p>Check to ensure that the voltage selector switch on the rear panel is set to the proper voltage.</p> <p>Turn the monitor off and let it charge for approximately 10 minutes and then reattempt to turn the unit on. If the error code is still present, turn the unit off and let it continue to charge. If the monitor has been charged for 30 minutes and the error code is still present, notify service personnel.</p> |



## Prompts and Error Messages

Prompt/Error Messages are displayed in the menu area. Prompt messages prompt a user for a response while error messages provide information to the user. The two figures below show examples of a prompt and an error message.

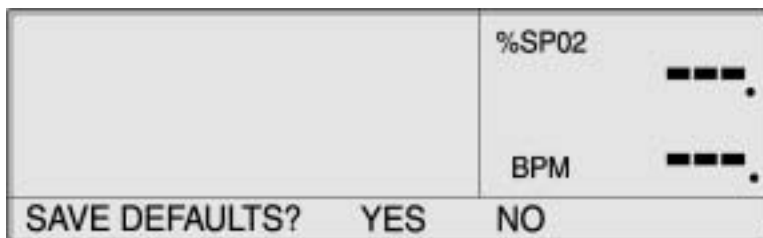

Table 10 on page 120 describes the N-595 prompt/error messages. Time-out is the maximum time that the message will remain displayed. If Time-out is None, the message will remain displayed until the condition is corrected or until an exit event occurs. Some messages will Exit on Alarm and/or Exit on Alarm Silence button press. Messages are prioritized so that more important messages will overwrite lower priority messages. Messages of the same priority will be displayed in order of occurrence. For multiple messages, lower priority messages will be displayed when higher priority conditions are cleared. The highest priority is 1 and the lowest is 3. Messages

that are advisory will be centered on the display. Prompts are those messages requiring a response (yes or no) and will be left justified.

**Table 10: Prompt/Error Messages**

| Message            | Time-out (sec.) | Exit on Alarm | Exit on Alarm Silence | When Displayed  | How Cleared  |
|--------------------|-----------------|---------------|-----------------------|---|--|
| CLOCK SETTING LOST | None            | No            | No                    | If the N-595 detects that the real time clock has stopped running. This will occur when both battery and AC power are lost. | After the monitor is power-cycled.   |
| DATA IN SENSOR     | 5               | No            | Yes                   | When a sensor containing data is connected to the monitor.  | On time-out, sensor disconnect, or pressing the ALARM SILENCE button, whichever comes first. |
| DATA TYPE SPO2+BPM | 5               | No            | Yes                   | When a blank event sensor is connected to a monitor with event data type set to SPO2+BPM.                                   | On time-out, sensor disconnect, or pressing the ALARM SILENCE button, whichever comes first. |
| DATA TYPE: SPO2    | 5               | No            | Yes                   | When a blank event sensor is connected to a monitor with event data type set to SPO2.                                       | On time-out, sensor disconnect, or pressing the ALARM SILENCE button, whichever comes first. |

Troubleshooting

**Table 10: Prompt/Error Messages**

| Message   | Time-out (sec.) | Exit on Alarm | Exit on Alarm Silence | When Displayed  | How Cleared   |
|---|-----------------|---------------|-----------------------|---|---|
| DEFAULTS LOST   | None            | No            | No                    | If the N-595 detects that power-on settings have been lost.                             | After the monitor is power-cycled.  |
| DELETE TRENDS?  | 10              | Yes           | Yes                   | When the user attempts to delete trend data from memory by pressing the DELETE softkey. | After the user responds to the prompt.  |
| LOW BATTERY   | None            | No            | Yes (1)               | When the monitor is on battery power and the battery charge is low.                     | When the monitor is connected to AC power or when the low battery is acknowledged by pressing the ALARM SILENCE button. |
| (1) The first press of the Alarm Silence softkey will silence any audible tone and the second press will clear the message. |                 |               |                       |   |   |
| READING TRENDS ...  | None            | Yes           | Yes                   | When the N-595 needs more than 4 to 6 seconds to retrieve trend data from memory.       | When sensor data is completely retrieved or ABORT is selected.  |
| SENSOR DISCONNECTED   | None            | No            | Yes <sup>1</sup>      | When the sensor is disconnected from the monitor.                                       | When the sensor is reconnected or when the sensor disconnection is acknowledged by pressing the ALARM SILENCE button.   |

**Table 10: Prompt/Error Messages**

| Message     | Time-out (sec.) | Exit on Alarm | Exit on Alarm Silence | When Displayed   | How Cleared |
|-------------|-----------------|---------------|-----------------------|--|-------------|
| SENSOR TYPE | 5               | No            | No                    | First message displayed when a sensor is connected to the monitor. | Time-out    |

## Corrective Action

If you experience a problem while using the N-595 and are unable to correct it, contact qualified service personnel or your local Nellcor representative. The N-595 service manual, which is for use by qualified service personnel, provides additional troubleshooting information.

The current copy of the N-595 service manual is available on the Internet at:

[http://www.mallinckrodt.com/respiratory/resp/Serv\\_Supp/ProductManuals.html](http://www.mallinckrodt.com/respiratory/resp/Serv_Supp/ProductManuals.html)

Following is a list of possible errors and suggestions for correcting them.

### 1. There is no response to the ON/STANDBY button.

- Ensure that the supply voltage selector switch is set to the proper voltage.
- A fuse may be blown. Notify service personnel to check and, if necessary, replace the fuse.
- If operating on battery power, the battery may be missing or discharged. If the battery is discharged, charge the battery, see *Operating the N-595 on Battery Power* on

---

page 21. If the battery will not charge, notify service personnel to replace the battery.

**2. One or more display elements or indicators do not light during the power-on self-test.**

- Do not use the N-595; contact qualified service personnel or your local Nellcor representative.

**3. The monitor is operating on battery power, even though it is connected to AC.**

- Ensure that the supply voltage selector switch is set to the proper voltage.
- Make sure that the power cord is properly connected to the N-595.
- Check to see if power is available to other equipment on the same AC circuit.

**4. The Pulse Search Indicator is lit for more than 10 seconds (before any measurements are taken).**

- Check the *OxIMAX* sensor directions for use to determine if an appropriate *OxIMAX* sensor is being used and if it is applied properly. Check *OxIMAX* sensor and pulse oximetry cable connections. Test the *OxIMAX* sensor on someone else. Try another *OxIMAX* sensor or pulse oximetry cable.
- Perfusion may be too low for the N-595 to track the pulse. Check the patient. Test the instrument on someone else. Change the *OxIMAX* sensor site. Try another type of *OxIMAX* sensor.

- Excessive patient motion may be preventing the N-595 from tracking the pulse. Keep the patient still, if possible. Verify that the *OxiMAX* sensor is securely applied, and replace it if necessary. Change the *OxiMAX* sensor site. Use a type of *OxiMAX* sensor that tolerates more patient movement; for example, an adhesive *OxiMAX* sensor.
- The *OxiMAX* sensor may be too tight, there may be excessive ambient light, or the *OxiMAX* sensor may be on an extremity with a blood pressure cuff, arterial catheter, or intravascular line. Reposition the *OxiMAX* sensor, as necessary.
- Excessive environmental motion or electromagnetic interference may be preventing the N-595 from tracking the pulse. Remove the source of interference or try to stabilize the environment, or do both.

**5. The Pulse Search Indicator lights after successful measurements have been made.**

- Check the patient.
- Perfusion may be too low for the N-595 to track the pulse. Test the instrument on someone else. Change the *OxiMAX* sensor site. Try another type of *OxiMAX* sensor.
- Excessive patient motion may be preventing the N-595 from tracking the pulse. Verify that the *OxiMAX* sensor is securely applied and replace it if necessary. Change the *OxiMAX* sensor site. Use a type of *OxiMAX* sensor that tolerates more patient movement; for example, an adhesive *OxiMAX* sensor.
- The *OxiMAX* sensor may be too tight, there may be excessive ambient light, or the *OxiMAX* sensor may be on an extremity with a blood pressure cuff, arterial catheter, or intravascular line. Reposition the *OxiMAX* sensor, as necessary.

- Excessive environmental motion or electromagnetic interference may be preventing the N-595 from tracking the pulse. Remove the source of interference or try to stabilize the environment, or do both.

## 6. The letters EEE, followed by a number, appear on the display.

- This is an error code. To confirm, press the ON/STANDBY button to turn the monitor off, then press the button again to turn it back on. If the display shows the error code once again, record the number and provide that information to qualified service personnel, or your local Nellcor representative.
- Error Code “EEE 4” is displayed when the battery is discharged to a critically low level. Check to ensure that the voltage selector switch on the rear panel is set to the proper voltage for your location.
- Turn the monitor off and let it charge for about 10 minutes and then turn the unit back on. If the error code is still present, turn the unit off and let it continue to charge. If the monitor has been charged for 30 minutes and the error code is still present, notify service personnel.

## EMI (Electro-magnetic Interference)



**Caution: This device has been tested and found to comply with the limits for medical devices to the IEC 60601-1-1-2 (second edition), EN60601-1-2, and the Medical Device Directive 93/42/EEC. These limits are designed to provide reasonable protection against harmful interference in a typical medical installation.**

However, because of the proliferation of radio-frequency transmitting equipment and other sources of electrical noise in health care environments (for example, electrosurgical units, cellular phones,

mobile two-way radios, electrical appliances, and high-definition television), it is possible that high levels of such interference due to close proximity or strength of a source may result in disruption of performance of this device.

The N-595 is designed for use in environments in which the pulse can be obscured by electromagnetic interference. During such interference, measurements may seem inappropriate or the monitor may not seem to operate correctly.

Disruption may be evidenced by erratic readings, cessation of operation, or other incorrect functioning. If this occurs, the site of use should be surveyed to determine the source of this disruption, and the following actions taken to eliminate the source:

- Turn equipment in the vicinity off and on to isolate the offending equipment.
- Reorient or relocate the interfering equipment.
- Increase the separation between the interfering equipment and this equipment.

The N-595 generates, uses, and can radiate radio frequency energy and, if not installed and used in accordance with these instructions, may cause harmful interference with other devices in the vicinity.

If assistance is required, contact Nellcor's Technical Services Department, 1.800.635.5267, or your local Nellcor representative.

---

## Obtaining Technical Assistance

For technical information and assistance, or to order parts or a service manual, contact Nellcor's Technical Services Department, 1.800.635.5267, or your local Nellcor representative. The service manual includes block diagrams and a parts list required by qualified personnel when servicing the N-595.



When calling Nellcor's Technical Services Department, 1.800.635.5267, or your local Nellcor representative, you may be asked to tell the representative the software version number of your N-595.

The software version appears in the monitor display each time the monitor successfully completes the power-on self-test. Write the number down and have it available whenever requesting technical assistance.

The current copy of this manual and the N-595 service manual are available on the Internet at:



[http://www.mallinckrodt.com/respiratory/resp/Serv\\_Supp/ProductManuals.html](http://www.mallinckrodt.com/respiratory/resp/Serv_Supp/ProductManuals.html)

---

## **OxIMAX Sensor Message Setup**

The *OxIMAX* sensor message setup display allows the user to enable or disable the *OxIMAX* sensor message feature. When disabled, neither the "SENSOR NOT POSTING" nor the "RECOMMENDED ACTION" messages will be displayed.

With the monitor in the normal monitoring mode:

- SETUP** 1. Press the SETUP softkey.  

- SENSOR** 2. Press the SENSOR softkey.  

**MSG**

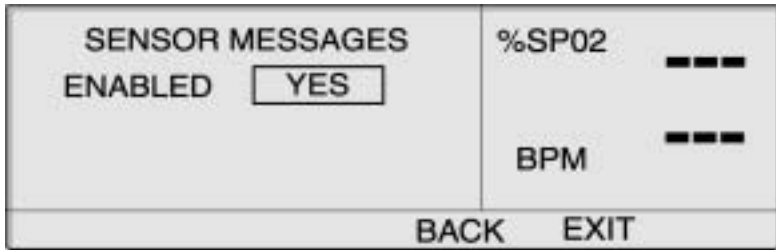

3. Press the MSG softkey.



4. Press the ADJUST UP or ADJUST DOWN button to toggle the ENABLE message.

**EXIT**



5. Press the EXIT softkey.

# Maintenance

---

Follow local governing ordinance and recycling instructions regarding the disposal or recycling of the N-595 and accessories.

---

## Returning the N-595

Contact Nellcor's Technical Services Department, 1.800.635.5267, or your local Nellcor representative for shipping instructions including a Returned Goods Authorization (RGA) number. Unless otherwise instructed by Nellcor's Technical Services Department, it is not necessary to return the *OxiMAX* sensor or other accessory items with the monitor. Pack the N-595 in its original shipping carton. If the original carton is not available, use a suitable carton with appropriate packing material to protect it during shipping.

Return the N-595 by any shipping method that provides proof of delivery.

---

## Service



---

**WARNING: The cover should be removed only by qualified service personnel. There are no user-serviceable parts inside.**

---

The N-595 requires no calibration.

The battery should be replaced at least every 24 months. Refer to the N-595 service manual for the battery changing procedure.

If service is necessary, contact qualified service personnel or your local Nellcor representative.

---

## Periodic Safety Checks

It is recommended that the following checks be performed every 24 months.

- Inspect the equipment for mechanical and functional damage.
- Inspect the safety relevant labels for legibility.

---

## Cleaning



**Caution: Do not spray, pour, or spill any liquid on the N-595, its accessories, connectors, switches, or openings in the chassis.**

For *surface-cleaning* and *disinfecting* the monitor, follow your institution's procedures or:

- The N-595 may be *surface-cleaned* by using a soft cloth dampened with either a commercial, nonabrasive cleaner or a solution of 70% alcohol in water, and lightly wiping the surfaces of the monitor.
- The N-595 may be *disinfected* using a soft cloth saturated with a solution of 10% chlorine bleach in tap water.

Before attempting to clean an SpO<sub>2</sub> *OxiMAX* sensor, read the directions for use enclosed with the *OxiMAX* sensor. Each *OxiMAX* sensor model has cleaning instructions specific to that *OxiMAX* sensor.

Follow the *OxiMAX* sensor cleaning and disinfecting procedures in the particular *OxiMAX* sensor's directions for use.

# Menu Structure

---

---

## N-595 Menu Description

The N-595 menu and hierarchy are outlined below. The user chooses the type of trend data to view by selecting either Monitor trend or Sensor trend data in the Trend menu. Sensor sub-menu choices differ depending on what type of in-sensor data is stored in the sensor chip, such as, event or loop.

The menu structure includes BACK softkey options that allow the user to move back to the previous menu level without exiting the Trend menu entirely. Trend data must be compiled on entry/reentry to the Trends menu. When the softkeys are available, both BACK and EXIT options are available. The BACK softkey goes to the previous level and the EXIT softkey goes to the main menu. If only one space is available the BACK Softkey is included, this may require going back one or two levels to get to an EXIT softkey.

The BACK and EXIT softkeys are positioned on the right-most softkeys, respectively.

The below menu structure identifies:

- **BOLDFACE TYPE** — softkey title as displayed on the monitor
- Underlined Text — description of the softkey menu item
- *Italicized Text* — the destination of the BACK and EXIT softkeys

(Main Menu)  
**LIMITS** (Limits Menu)  
- **SELECT**  
- **NEO**

- **ADULT**
  - **EXIT** (to Main menu)
  - **TREND** (Trend Menu)
    - **MON** (Monitor Menu)
      - **VIEW** (Monitor Trend View Menu)
        - **DUAL**
        - **SPO2**
        - **PULSE**
        - **NEXT** (History/Amplitude Menu)
          - **HIST** (Delete/Print2 Menu)
            - **DELETE** (delete Trends)
              - "DELETE TRENDS"
                - **YES** (return to Main menu)
                - **NO** (back to Delete/Print menu)
      - **PRINT**
      - **BACT** (back to Hist/Amp menu)
      - **EXIT** (to Main menu)
      - **AMP** (Amplitude Menu)
        - **BACK** (back to Hist/Amp menu)
        - **EXIT** (to Main menu)
      - **BACK** (back to Monitor Trend View menu)
      - **EXIT** (to Main menu)
    - **ZOOM** (Monitor Trend Zoom Menu)
      - **TIME** (for current view, cycle through 48h, 36h, 12h, 8h, 4h, 2h, 1h, 30m, 15m, 40s, 20s)
      - **SCALE** (for current view, cycle through  $\pm 5$ ,  $\pm 10$ ,  $\pm 15$ ,  $\pm 20$ ,  $\pm 25$ ,  $\pm 30$ ,  $\pm 35$ ,  $\pm 40$  and  $\pm 50$  of the max and min. values under the cursor, default to 10 to 100 if there is no data point under the cursor)
      - **AUTO** (based on all of the graphed trend data: maximum value, rounded up to nearest multiple of 10, minimum value, rounded down to nearest multiple of 10 minus 10)
      - **BACK** (back to Monitor menu)
  - **NEXT** (Delete/Print1 Menu)
    - **DELETE**
      - "DELETE TRENDS?"
        - **YES** (to Main menu)
        - **NO** (back to Delete/Print1 menu)
    - **PRINT**
    - **BACK** (back to Monitor menu)
    - **EXIT** (to Main menu)
  - **BACK** (back to Trend menu)
- **SENSOR** (Sensor/Event Menu)

(if Event data is in the sensor, the following menu, the Screen will remain in the appropriate state until the next menu selection is made)

- - **GRAPH** (Graph Menu) (*display events #1-N, in inverse chronological order; up/down also scroll through events in order*)
  - - - < (*show previous graph, only available when there is a previous graph*)
  - - - > (*show next graph, only available when there is a next graph*)
  - - - **PRINT**
  - - - **BACK** (*back to Sensor menu*)
- - **TABLE** (Table Menu)
  - - - ^ (*show previous table, only available when there is a previous graph; bottom/top line repeats in new table*)
  - - - v (*show next table, only available when there is a next graph; bottom/top line repeats in new table*)
  - - - **PRINT**
  - - - **BACK** (*back to Sensor menu*)
  - - - **EXIT** (*to Main menu*)

(Sensor/Loop Menu) (*If continuous-Loop data is in the sensor, the following will be displayed*)

- - **VIEW** (Sensor Trend View Menu)
  - - - **DUAL** (*shows SPO2+BPM*)
  - - - **SPO2**
  - - - **PULSE**
- - **ZOOM** (*cycle through 2h, 1h, 30m, and 15m for current view*)
- - **PRINT**
- - **BACK** (*to Trend menu*)
- **EXIT** (*to Main menu*)

**SETUP** (Setup Monitor Menu)

- **VIEW** (Setup View Menu)
  - **PLETH**
  - **BLIP**
  - **BACK** (*back to Setup menu*)
  - **EXIT** (*to Main menu*)
- **SENSOR** (Setup Sensor Menu)
  - **DATA** (*On-screen options for SENSOR-R (Write-once Sensor) sensor are: "SPO2, SPO2+BPM, DEFAULT." On-screen options for SENSOR-RW (rewritable sensor) are: "SPO2, SPO2+BPM, DEFAULT." SELECT toggles SENSOR-R or SENSOR-RW sensor type; up/down keys scroll*)

through options in order.) The SENSOR-R feature supports all of the current OxiMAX sensors.

- - - **SELECT**
- - - **BACK** (back to Setup Sensor menu)
- - - **EXIT** (to Main menu)
- - **MSG** (Sensor Set Message Menu)
- - - **BACK** (back to Setup Sensor menu)
- - - **EXIT** (to Main menu)
- **NEXT** (Clock/Language Menu)
- - **CLOCK** (Clock Menu)
- - - **SET** (Clock Set Menu)
- - - - **SELECT** (press select to toggle through hours, minutes, seconds, month, day, year; use up/down buttons to set each selection)
- - - - **BACK** (back to Clock/Language menu)
- - - - **EXIT** (to Main menu)
- - **LANG** (Language Setup Menu) (use up/down buttons to toggle through languages)
- - - **BACK** (back to Clock/Language menu)
- - **NEXT** (Communication/Nurse Call Menu)
- - - **COMM** (Communication Port Configuration Menu)
- - - - **SELECT**
- - - - **BACK** (back to Communication/Language menu)
- - - - **EXIT** (to Main menu)
- - - **NCALL** (Nurse Call Menu)
- - - - **NORM +**
- - - - **NORM -**
- - - - **BACK** (back to Communication/Nurse Call menu)
- - - - **EXIT** (to Main menu)
- - - **NEXT** (Analog/Mode Menu)
- - - - **ANALOG** (Analog Voltage Select Menu)
- - - - - **0 VOLT**
- - - - - **1 VOLT**
- - - - - **STEP**
- - - - - **BACK** (back to Analog/Mode menu)
- - - - **MODE** (Mode Menu)
- - - - - **BACK** (back to Analog/Mode menu)
- - - - - **EXIT** (to Main menu)
- - - - **BACK** (back to Communication/Nurse Call menu)
- - - - **EXIT** (to Main menu)
- - - **BACK** (back to Clock/Language menu)
- - **BACK** (back to Setup menu)
- **EXIT** (to Main menu)
- LIGHT** (Turns the display backlight on or off)



# *SatSeconds*

---

---

## **Describing *SatSeconds***

With traditional alarm management, upper and lower alarm limits are set for monitoring oxygen saturation. During monitoring, as soon as an alarm limit is violated by as little as one percentage point, an audible alarm immediately sounds. When the %SpO<sub>2</sub> level fluctuates near an alarm limit, the alarm sounds each time the limit is violated. Such frequent alarms can be distracting.

The N-595 pulse oximeter utilizes Nellcor *SatSeconds* alarm management technique. With the *SatSeconds* technique, upper and lower alarm limits are set in the same way as with traditional alarm management. The clinician also sets a *SatSeconds* limit that allows the monitoring of %SpO<sub>2</sub> below the selected low alarm limit for a period of time before an audible alarm sounds.

The *SatSeconds* limit controls the time that the %SpO<sub>2</sub> level may fall outside the alarm before an audible alarm sounds.

The method of calculation is as follows:

The number of percentage points that the %SpO<sub>2</sub> falls outside of the alarm limit is multiplied by the number of seconds that the %SpO<sub>2</sub> level remains outside that limit. This can be stated as an equation:

$$\text{Points} \times \text{Seconds} = \textit{SatSeconds}$$

Where:

Points = %SpO<sub>2</sub> percentage points outside of the limit

Seconds = number of seconds the %SpO<sub>2</sub> remains at that point outside of the limit

The alarm response time, assuming a *SatSeconds* limit set at 50 and a lower alarm limit set at 90, is described and illustrated below.

In this example, the %SpO<sub>2</sub> level drops to 88 (2 points) and remains there for a period of 2 seconds (2 points x 2 seconds = 4 *SatSeconds*). The %SpO<sub>2</sub> then drops to 86 for 3 seconds and then to 84 for 6 seconds. The resulting *SatSeconds* are:

| %SpO <sub>2</sub>         | Seconds | <i>SatSeconds</i> |
|---------------------------|---------|-------------------|
| 2 x                       | 2 =     | 4                 |
| 4 x                       | 3 =     | 12                |
| 6 x                       | 6 =     | 36                |
| Total <i>SatSeconds</i> = |         | 52                |

After approximately 10.9 seconds the *SatSeconds* alarm would sound, because 50 *SatSeconds* had been exceeded. See the arrow (↑) in Figure 13 on page 136.

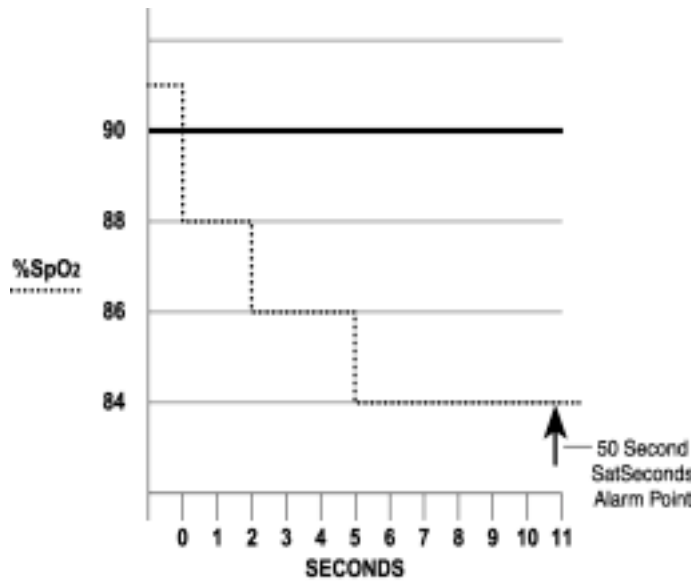

**Figure 13: Alarm Response with *SatSeconds***

Saturation levels may fluctuate rather than remain steady for a period of several seconds. Often, the %SpO<sub>2</sub> levels may fluctuate above and below the alarm limit, re-entering the non-alarm range several times.

During such fluctuations, the N-595 pulse oximeter integrates the number of %SpO<sub>2</sub> points, both positive and negative, until either the *SatSeconds* limit (*SatSeconds* time setting) is reached, or the %SpO<sub>2</sub> level returns to within a normal range and remains there.

## SatSeconds “Safety Net”

The *SatSeconds* “Safety Net” is for patients with saturation levels having frequent excursions below the limit, but not staying below the limit long enough for the *SatSeconds* time setting to be reached. When 3 or more limit violations occur within 60 seconds, an alarm will sound even if the *SatSeconds* time setting has not been reached.

## SatSeconds Display

When the N-595 *SatSeconds* technology detects an SpO<sub>2</sub> value outside the alarm limit, the *SatSeconds* indicator (the circular graph located on the right side of the display, adjacent to the SpO<sub>2</sub> reading) begins to “fill” clockwise. When the SpO<sub>2</sub> value is within the set limits, the *SatSeconds* indicator will empty counter-clockwise.

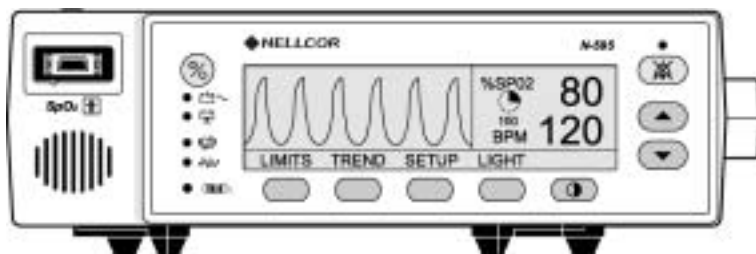

When the indicator is completely filled, indicating that the *SatSeconds* setting has been reached, an audible alarm sounds and the displayed %SpO<sub>2</sub> rate flashes. As with traditional alarm management,

the audible alarm may be silenced by pressing the ALARM SILENCE button.

# Factory Defaults

---

The N-595 is shipped with factory default settings. Authorized technical personnel using the procedures described in the N-595 service manual can change default settings.

---

## Neonate Default Settings

**Table 11: Neonate Factory Defaults**

| <b>Parameter</b>                        | <b>Setting</b>      |
|---|---------------------|
| Monitoring Mode                         | Neo                 |
| %SpO2 Lower Alarm Limit                 | 80%                 |
| %SpO2 Upper Alarm Limit                 | 95%                 |
| Allow silence duration to be set to OFF | Yes                 |
| Alarm Silence Duration                  | 60 seconds          |
| Alarm Silence Reminder                  | Enabled             |
| Alarm Volume                            | 7 of 10             |
| Data Port Baud Rate                     | 9600                |
| Data Port Protocol                      | ASCII               |
| Display Contrast                        | Midrange            |
| Display Format                          | Pleth               |
| Language                                | English             |
| Nurse Call Polarity                     | Normally Low        |
| Pulse Beep Volume                       | 4 of 10             |
| Pulse Rate Lower Alarm Limit            | 90 beats per minute |

**Table 11: Neonate Factory Defaults**

| <b>Parameter</b>             | <b>Setting</b>       |
|------------------------------|----------------------|
| Pulse Rate Upper Alarm Limit | 190 beats per minute |
| Response Mode                | Normal               |
| <i>SatSeconds</i>            | Off                  |
| Trend Display                | %SpO2                |
| Trend Scale                  | 2 hours              |

## Adult Default Settings

**Table 12: Adult Factory Defaults**

| <b>Parameter</b>                        | <b>Setting</b> |
|---|----------------|
| Monitoring Mode                         | Adult          |
| %SpO2 Lower Alarm Limit                 | 85%            |
| %SpO2 Upper Alarm Limit                 | 100%           |
| Allow silence duration to be set to OFF | Yes            |
| Alarm Silence Duration                  | 60 seconds     |
| Alarm Silence Reminder                  | Enabled        |
| Alarm Volume                            | 7 of 10        |
| Data Port Baud Rate                     | 9600           |
| Data Port Protocol                      | ASCII          |
| Display Contrast                        | Midrange       |
| Display Format                          | Pleth          |
| Language                                | English        |
| Nurse Call Polarity                     | Normally Low   |

**Table 12: Adult Factory Defaults**

| <b>Parameter</b>             | <b>Setting</b>       |
|------------------------------|----------------------|
| Pulse Beep Volume            | 4 of 10              |
| Pulse Rate Lower Alarm Limit | 40 beats per minute  |
| Pulse Rate Upper Alarm Limit | 170 beats per minute |
| Response Mode                | Normal               |
| <i>SatSeconds</i>            | Off                  |
| Trend Display                | %SpO <sub>2</sub>    |
| Trend Scale                  | 2 hours              |





# *Principles of Operation*

---

---

## **Oximetry Overview**

The N-595 uses pulse oximetry to measure functional oxygen saturation in the blood. Pulse oximetry works by applying an *OxiMAX* sensor to a pulsating arteriolar vascular bed, such as a finger or toe. The *OxiMAX* sensor contains a dual light source and a photo detector.

Bone, tissue, pigmentation, and venous vessels normally absorb a constant amount of light over time. The arteriolar bed normally pulsates and absorbs variable amounts of light during the pulsations. The ratio of light absorbed is translated into a measurement of functional oxygen saturation (SpO<sub>2</sub>).

Because a measurement of SpO<sub>2</sub> is dependent upon light from the *OxiMAX* sensor, excessive ambient light can interfere with this measurement.

Specific information about ambient conditions, *OxiMAX* sensor application, and patient conditions is contained throughout this manual.

Pulse oximetry is based on two principles: that oxyhemoglobin and deoxyhemoglobin differ in their absorption of red and infrared light (spectrophotometry), and that the volume of arterial blood in tissue (and hence, light absorption by that blood) changes during the pulse (plethysmography). A pulse oximeter determines SpO<sub>2</sub> by passing red and infrared light into an arteriolar bed and measuring changes in light absorption during the pulsatile cycle. Red and infrared low-voltage light-emitting diodes (LED) in the oximetry *OxiMAX* sensor serve as light sources; a photo diode serves as the photo detector.

Because oxyhemoglobin and deoxyhemoglobin differ in light absorption, the amount of red and infrared light absorbed by blood is related to hemoglobin oxygen saturation. To identify the oxygen

saturation of arterial hemoglobin, the monitor uses the pulsatile nature of arterial flow. During systole, a new pulse of arterial blood enters the vascular bed, and blood volume and light absorption increase. During diastole, blood volume and light absorption reach their lowest point. The pulse oximeter bases its SpO<sub>2</sub> measurements on the difference between maximum and minimum absorption (measurements at systole and diastole). By doing so, it focuses on light absorption by pulsatile arterial blood, eliminating the effects of nonpulsatile absorbers such as tissue, bone, and venous blood.

---

## Automatic Calibration

Because light absorption by hemoglobin is wavelength dependent and because the mean wavelength of LEDs varies, an oximeter must know the mean wavelength of the *OxiMAX* sensor's red LED to accurately measure SpO<sub>2</sub>.

During monitoring, the instrument's software selects coefficients that are appropriate for the wavelength of that individual *OxiMAX* sensor's red LED; these coefficients are then used to determine SpO<sub>2</sub>.

Additionally, to compensate for differences in tissue thickness, the light intensity of the *OxiMAX* sensor's LEDs is adjusted automatically.

---

## Functional versus Fractional Saturation

This pulse oximeter measures functional saturation – oxygenated hemoglobin expressed as a percentage of the hemoglobin that can transport oxygen. It does not detect significant amounts of dysfunctional hemoglobin, such as carboxyhemoglobin or methemoglobin. In contrast, hemoximeters such as the IL482 report fractional saturation – oxygenated hemoglobin expressed as a percentage of all measured hemoglobin, including measured dysfunctional hemoglobins. To compare functional saturation measurements to those from an instrument that measures fractional saturation, fractional measurements must be converted as follows:

$$\text{functional saturation} = \frac{\text{fractional saturation}}{100 - (\% \text{ carboxyhemoglobin} + \% \text{ methemoglobin})} \times 100$$

## Measured versus Calculated Saturation

When saturation is calculated from a blood gas partial pressure of oxygen ( $PO_2$ ), the calculated value may differ from the  $SpO_2$  measurement of a pulse oximeter. This usually occurs because the calculated saturation was not appropriately corrected for the effects of variables that shift the relationship between  $PO_2$  and pH, temperature, the partial pressure of carbon dioxide ( $PCO_2$ ), 2,3-DPG, and fetal hemoglobin. See Figure 14 on page 145.

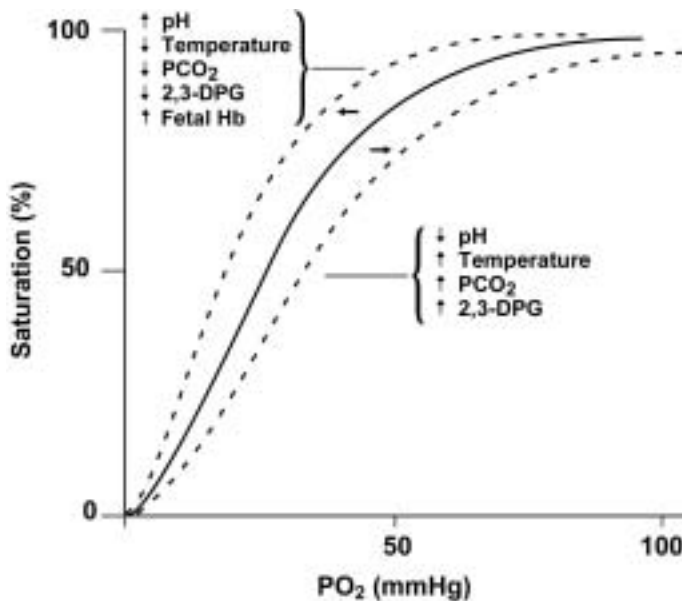

Figure 14: Oxyhemoglobin Dissociation Curve

## OxiMAX Technology

The N-595 pulse oximeter is designed to use Nellcor *OxiMAX* brand sensors, which integrate the *OxiMAX* technology. These *OxiMAX* sensors can be identified by their deep lavender/blue plug color. All *OxiMAX* sensors contain a memory chip carrying information about the *OxiMAX* sensor, which the oximeter needs for correct operation, including the *OxiMAX* sensor's calibration data, model type,

troubleshooting codes, and error detection data. This unique oximetry architecture enables development of new sensors as well as several new features with the *OxiMAX* sensor N-595.

When an *OxiMAX* sensor is connected to the N-595, the pulse oximeter will first read the information in the *OxiMAX* sensor memory chip, checks it to make sure that there are no errors, and then loads the data to begin monitoring. As the pulse oximeter reads the information, it displays the *OxiMAX* sensor model number. This process only takes a couple of seconds. The *OxiMAX* sensor model number disappears after 5 seconds.

Pulse oximeters containing *OxiMAX* technology, including the N-595, use calibration data contained in the *OxiMAX* sensor in calculating the patient's SpO<sub>2</sub>. Consult the *OxiMAX* sensor accuracy grid card included with the pulse oximeter for specific accuracy information for the N-595 with different Nellcor *OxiMAX* sensors.

The N-595 uses the information in the *OxiMAX* sensor to tailor troubleshooting messages for the clinician. The *OxiMAX* sensor contains coding that tells the pulse oximeter what kind of *OxiMAX* sensor is being used. When deciding what messages to display, the pulse oximeter takes into account the *OxiMAX* sensor type and recommended patient site for that model.

# Specifications

---

---

## Performance

### Measurement Range

|                  |                                      |
|------------------|--------------------------------------|
| SpO <sub>2</sub> | 1% to 100%                           |
| Pulse Rate       | 20 beats per minute (bpm) to 250 bpm |
| Perfusion Range  | 0.03% to 20%                         |

### Accuracy and Motion Tolerance

|  |  |
|--|--|
| Saturation                                     |  |
| Without Motion - Adults <sup>1</sup>           | 70 to 100% $\pm 2$ digits                              |
| Without Motion - Neonate <sup>1</sup>          | 70 to 100% $\pm 3$ digits                              |
| With Motion - Adults and Neonates <sup>2</sup> | 70 to 100% $\pm 3$ digits                              |
| Low Perfusion <sup>3</sup>                     | 70 to 100% $\pm 2$ digits                              |
| Pulse Rate                                     |  |
| Without Motion <sup>1, 2, 3</sup>              | 20 to 250 bpm $\pm 3$ digits                           |
| With Motion <sup>2</sup>                       | normal physiologic range (55 - 125 bpm) $\pm 5$ digits |
| Low Perfusion <sup>3</sup>                     | 20 to 250 bpm $\pm 3$ digits                           |

---

### Accuracy and Motion Tolerance

---

<sup>1</sup> Adult specifications are shown for *OxiMAX* MAX-A and MAX-N sensors with the N-595. Neonate specifications are shown for *OxiMAX* MAX-N sensors with the N-595. Saturation accuracy will vary by sensor type. Refer to the Sensor Accuracy Grid. The Sensor Accuracy Grid is shipped with the monitor. The latest version of the Sensor Accuracy Grid is available on the Internet at:

[http://www.mallinckrodt.com/respiratory/resp/Serv\\_Supp/ProductManuals.html](http://www.mallinckrodt.com/respiratory/resp/Serv_Supp/ProductManuals.html)

<sup>2</sup> Applicability: *OxiMAX* MAX-A, MAX-AL, MAX-P, MAX-I, and MAX-N sensors.

<sup>3</sup> Specification applies to monitor performance.

---

---

### Display Update Interval

---

2 seconds

---

## Electrical

---

### Instrument

---

|                    |  |
|--------------------|--|
| Power Requirements | rated at 108 to 132 volts AC (nominal 120 VAC) or 220 to 240 volts AC (nominal 230 VAC), 20 volt/amps to be compliant with IEC 60601-1 sub-clause 10.2.2 |
| Fuses              | qty 2, 0.5 A, 250 volts, slow-blow, IEC (5 x 20 mm)  |

---

---

### Battery

---

The battery provides at least 2 hours of battery life when new and fully charged with no alarms, no serial data, no analog output, no nurse call output, with backlight on while using a pulse simulator set for 224 bpm, high light and low modulation.

**Battery**

|               |  |
|---------------|--|
| Type          | Lead acid  |
| Voltage       | 6 Volts DC   |
| Recharge      | <ul style="list-style-type: none"> <li>• 14 hours with N-595 turned off</li> <li>• 18 hours with N-595 operating</li> </ul>  |
| Shelf Life    | <ul style="list-style-type: none"> <li>• 2 months, new fully charged battery</li> <li>• After 2 months storage, the N-595 will run for 50% of stated battery life</li> </ul> |
| Complies With | 91/157/EEC   |

***OxiMAX* Sensors**

|                      |   |
|----------------------|---|
| Wavelength and Power | The wavelength range of the light emitted are near 660 nm and 890 nm with the energy not exceeding 15 mW. |
|----------------------|---|

**Environmental Conditions**

**Operation**

|                      |   |
|----------------------|---|
| Temperature          | 5 °C to 40 °C (41 °F to 104 °F)                   |
| Altitude             | -390 m to 3,012 m<br>(-1,254 ft. to 9,882 ft.)    |
| Atmospheric Pressure | 70 kPa to 106 kPa<br>(20.6 in. Hg to 31.3 in. Hg) |

**Operation**

|                   |   |
|-------------------|---|
| Relative Humidity | 15% to 95% non-condensing to be compliant with IEC 60601-1, sub-clause 44.5 |
|-------------------|---|

**Transport and Storage (not in shipping container)**

|                      |   |
|----------------------|---|
| Temperature          | -20 °C to 60 °C<br>(-4 °F to 140 °F)              |
| Altitude             | -390 m to 5,574 m<br>(-1,280 ft. to 18,288 ft.)   |
| Atmospheric Pressure | 50 kPa to 106 kPa<br>(14.7 in. Hg to 31.3 in. Hg) |
| Relative Humidity    | 15% to 95% non-condensing                         |

**Transport and Storage (in shipping container)**

|                      |   |
|----------------------|---|
| Temperature          | -20 °C to 70 °C<br>(-4 °F to 158 °F)              |
| Altitude             | -390 m to 5,574 m<br>(-1,280 ft. to 18,288 ft.)   |
| Atmospheric Pressure | 50 kPa to 106 kPa<br>(14.7 in. Hg to 31.3 in. Hg) |
| Relative Humidity    | 15% to 95% non-condensing                         |

***OxiMAX* Sensor Power Dissipation**

| <b>Sensor</b>       | <b>Dissipation</b> |
|---------------------|--------------------|
| <i>OxiMAX</i> MAX-N | 52.5 mW            |
| <i>OxiMAX</i> MAX-I | 52.5 mW            |



**OxIMAX Sensor Power Dissipation**

| <b>Sensor</b>                    | <b>Dissipation</b> |
|----------------------------------|--------------------|
| <i>OxIMAX</i> MAX-P              | 52.5 mW            |
| <i>OxIMAX</i> MAX-A              | 52.5 mW            |
| <i>OxIMAX</i> MAX-AL             | 52.5 mW            |
| <i>OxIMAX</i> MAX-R              | 52.5 mW            |
| <i>OxIMAX Oxiband</i> OXI-A/N    | 52.5 mW            |
| <i>OxIMAX Oxiband</i> OXI-P/I    | 52.5 mW            |
| <i>OxIMAX Durasensor</i> DS-100A | 52.5 mW            |
| <i>OxIMAX OxiCliq</i> P          | 52.5 mW            |
| <i>OxIMAX OxiCliq</i> N          | 52.5 mW            |
| <i>OxIMAX OxiCliq</i> I          | 52.5 mW            |
| <i>OxIMAX OxiCliq</i> A          | 52.5 mW            |
| <i>OxIMAX Dura-Y</i> D-YS        | 52.5 mW            |
| <i>OxIMAX</i> MAX-FAST           | 52.5 mW            |

**Physical Characteristics**

|            |   |
|------------|---|
| Weight     | 5.8 lbs. (2.6 kg)   |
| Dimensions | 3.3 in. x 10.4 in. x 6.8 in. (8.4 cm x 26.4 cm x 17.3 cm) |

## Compliance

| Item  | Compliant With   |
|---|--|
| Equipment classification  | Safety Standards: IEC 60601-1 (same as EN60601-1), CSA 601.1,<br><br>UL 2601-1, EN865, EN/IEC 60601-1-2 (second edition) |
| Type of protection  | Class 1 (on AC power)<br><br>Internally powered (on battery power)   |
| Degree of protection  | Type BF - Applied part   |
| Mode of operation   | Continuous   |
| N-595 resistant to liquid ingress                                       | IEC 60601-1, sub-clause 44.6 for class IPX1 Drip-Proof equipment   |
| Degree of Safety in presence of a flammable anaesthetic                 | UL 2601-1, sub-clause 5.5, Not suitable  |
| Applied sensor label to indicate Type BF applied part                   | IEC 60601-1 Symbol 2 of Table DII of Appendix D  |
| Equipotential lug symbol to indicate a potential equalization conductor | IEC 60601-1 Symbol 9 of Table DI of Appendix D   |
| Attention symbol, consult accompanying documentation                    | IEC 60601-1 Symbols 14 of Table DI of Appendix D   |
| External case made with non-conductive plastic                          | IEC 60601-1, sub-clause 16(a)  |
| No holes in case top  | IEC 60601-1, sub-clause 16(b)  |
| 115/230 voltage selector switch   | IEC 60601-1, sub-clause 16(f)  |
| Rigid case  | IEC 60601-1, sub-clause 21(a)  |
| Case mechanically strong  | IEC 60601-1, sub-clause 21(b)  |
| Case handle   | IEC 60601-1, sub-clause 21(c)  |

| <b>Item</b>                                     | <b>Compliant With</b>   |
|---|---|
| N-595 resistant to rough handling               | IEC 60601-1, sub-clause 21.6                                  |
| N-595 tip/tilt test                             | IEC 60601-1, sub-clause 24.1                                  |
| N-595 resistant to liquid ingress due to spills | IEC 60601-1, sub-clause 44.3 as modified by EN 865, clause 4  |
| Environmental                                   | IEC 60601-1, sub-clause 44.5                                  |
| Cleaning  | IEC 60601-1, sub-clause 44.7                                  |
| Case surface made of non-toxic materials        | IEC 60601-1, sub-clause 48                                    |
| Case resistant to heat and fire                 | IEC 60601-1, sub-clause 59.2(b)                               |
| N-595 power entry module fuse holder            | IEC 60601-1, sub-clause 59.3                                  |
| N-595 exterior markings                         | IEC 60601-1, sub-clause 6.1, 6.3, and 6.4; EN 865, clause 6   |
| Front panel and case labeling                   | IEC 60878, EN 980, ISO 7000, EN 60417-1, EN 60417-2           |
| N-595 button spacing                            | ISO 7250  |
| Year of manufacture symbol                      | EN 980  |
| Conductive coating and polymeric materials      | UL 2601-1, clause 55  |
| Operation during physical shock                 | IEC 60068-2-27 at 100 g                                       |
| Operation during vibration                      | IEC 60068-2-6 and IEC 60068-2-34                              |
| Electromagnetic Compatibility                   | IEC 60601-1, sub clause 36, IEC/EN 60601-1-2 (second edition) |
| Radiated and conducted emissions                | EN 55011, Group 1, Class B                                    |
| Harmonic emissions                              | IEC 61000-3-2   |
| Voltage fluctuations/flicker emissions          | IEC 61000-3-3   |

| Item  | Compliant With                               |
|---|--|
| Electrostatic discharge immunity                        | EN 61000-4-2, level 3 table top equipment    |
| Radiated radio-frequency electromagnetic field immunity | IEC 61000-4-3 at 3V/m                        |
| Electrical fast transient/burst immunity                | IEC 61000-4-4, level 3                       |
| Surge immunity  | IEC 61000-4-5, level 3; FDA Reviewer's Guide |
| Conducted EMI susceptibility                            | IEC 61000-4-6 at 3 V/m                       |
| Power frequency magnetic fields                         | IEC 61000-4-8 at 3 V/m                       |
| Operation with line voltage variations                  | IEC 61000-4-11 for Table 7                   |
| Operation with electrical line voltage variations       | FDA Reviewer's Guide                         |
| Radiated magnetic field emissions                       | RE 101/Army/7cm of MIL-STD-461E              |
| Magnetic field susceptibility                           | RS 101 in MIL-STD-461E                       |
| Quasi-static electric field susceptibility              | FDA Reviewer's Guide                         |

## Manufacturer's Declaration



**WARNING:** The use of accessories, sensors, and cables other than those specified may result in increased emission and/or decreased immunity of the N-595 pulse oximeter.

**Table 13: Electromagnetic Emissions**

The N-595 is suitable for use in the specified electromagnetic environment. The customer and/or user of the N-595 should assure that it is used in an electromagnetic environment as described below:

| <b>Emissions Test</b>                                      | <b>Compliance</b> | <b>Electromagnetic Environment Guidance</b>  |
|--|-------------------|--|
| RF emission<br>CISPR 11                                    | Group 1           | The N-595 must emit electromagnetic energy in order to perform its intended function. Nearby electronic equipment may be affected. |
| RF emissions<br>CISPR 11                                   | Class B           | The N-595 is suitable for use in all establishments.   |
| Harmonic emissions<br>IEC 61000-3-2                        | Complies          |  |
| Voltage fluctuations/<br>flicker emission<br>IEC 61000-3-3 | Complies          |  |

**Table 14: Electromagnetic Immunity**

The N-595 is suitable for use in the specified electromagnetic environment. The customer and/or user of the N-595 should assure that it is used in an electromagnetic environment as described below.

| <b>Immunity Test</b>          | <b>IEC 60601-1-2 Test Level</b> | <b>Compliance Level</b>      | <b>Electromagnetic Environment Guidance</b>  |
|-------------------------------|---------------------------------|------------------------------|--|
| Electrostatic discharge (ESD) | ±6 kV contact                   | ±6 kV contact                | Floor should be wood, concrete, or ceramic tile. If floors are covered with synthetic material, the relative humidity should be at least 30 %. |
| IEC 61000-4-2                 | ±8 kV air                       | ±8 kV air                    |  |
| Electric fast transient/burst | ±2 kV for power supply lines    | ±2 kV for power supply lines | Mains power quality should be that of a typical commercial and/or hospital environment   |
| IEC 61000-4-4                 | ±1 kV for input/output lines    | ±1 kV for input/output lines |  |
| Surge                         | ±1 kV differential mode         | ±1 kV differential mode      | Mains power quality should be that of a typical commercial and/or hospital environment   |
| IEC 61000-4-5                 | ±2 kV common mode               | ±2 kV common mode            |  |

**Note:** UT is the AC mains voltage prior to application of the test level.

**Table 14: Electromagnetic Immunity**

The N-595 is suitable for use in the specified electromagnetic environment. The customer and/or user of the N-595 should assure that it is used in an electromagnetic environment as described below.

| Immunity Test  | IEC 60601-1-2 Test Level            | Compliance Level                    | Electromagnetic Environment Guidance  |
|--|-------------------------------------|-------------------------------------|---|
| Voltage dips, short interruptions and voltage variations on power supply | <5 % $U_T$                          | <5 % $U_T$                          | Mains power quality should be that of a typical commercial and/or hospital environment. If the user of the N-595 requires continued operation during power mains interruption, it is recommended that the N-595 be powered from an uninterruptible power supply or battery. |
|  | (>95 % dip in $U_T$ ) for 0.5 cycle | (>95 % dip in $U_T$ ) for 0.5 cycle |   |
| IEC 61000-4-11   | 40 % $U_T$                          | 40 % $U_T$                          |   |
|  | (60 % dip in $U_T$ ) for 5 cycles   | (60 % dip in $U_T$ ) for 5 cycles   |   |
|  | 70 % $U_T$                          | 70 % $U_T$                          |   |
|  | (30 % dip in $U_T$ ) for 25 cycles  | (30 % dip in $U_T$ ) for 25 cycles  |   |
|  | <5 % $U_T$                          | <5 % $U_T$                          |   |
|  | (95 % dip in $U_T$ ) for 5 sec.     | (95 % dip in $U_T$ ) for 5 sec.     |   |

**Note:**  $U_T$  is the AC mains voltage prior to application of the test level.



**Table 14: Electromagnetic Immunity**

The N-595 is suitable for use in the specified electromagnetic environment. The customer and/or user of the N-595 should assure that it is used in an electromagnetic environment as described below.

| Immunity Test  | IEC 60601-1-2 Test Level | Compliance Level | Electromagnetic Environment Guidance   |
|--|--------------------------|------------------|--|
| Power frequency (50/60 Hz) magnetic field<br><br>IEC 61000-4-8 | 3 A/m                    | 3 A/m            | It may be necessary to position the N-595 further from the sources of power frequency magnetic fields or to install magnetic shielding. The power frequency magnetic field should be measured in the intended installation location to assure that it is sufficiently low. |

**Note:** UT is the AC mains voltage prior to application of the test level.



**Table 15: Electromagnetic Immunity, RF Portable Equipment**

For portable and mobile communication equipment. The N-595 is suitable for use in the specified electromagnetic environment. The customer and/or user of the N-595 should assure that it is used in an electromagnetic environment as described below:

| Immunity Test  | IEC 60601-1-2 Test Level | Compliance Level | Electromagnetic Environment Guidance               |
|--|--------------------------|------------------|--|
| Portable and mobile RF communications equipment should be used no closer to any part of the N-595, including cables, than the recommended separation distance calculated from the equation appropriate for the frequency of the transmitter. |                          |                  |  |
| Recommended Separation Distance  |                          |                  |  |
| Radiated RF IEC 61000-4-3  | 3 V/m<br>80 MHz          | 3 V/m            | $distance = 1.2\sqrt{Power}$<br>80 MHz to 800 MHz  |
|  | 3 V/m<br>800 MHz         | 3 V/m            | $distance = 2.3\sqrt{Power}$<br>800 MHz to 2.5 GHz |
|  | 2.5 GHz                  |                  |  |

**Note:** Field strengths from fixed transmitters, such as base stations for radio (cellular/cordless) telephones and land mobile radios, amateur radio, AM and FM radio broadcast, and TV broadcast cannot be predicted theoretically with survey accuracy. To assess the electromagnetic environment due to fixed RF transmitters, an electromagnetic site survey should be considered. If the measured field strength in the location in which the N-595 is used exceeds the applicable RF compliance level above, the N-595 should be observed to verify normal operation. If abnormal performance is observed, additional measures may be necessary, such as re-orienting or relocating the N-595.

**Note:** These guidelines may not apply in all situations. Electromagnetic propagation is affected by absorption and reflection from structures, objects, and people.

Interference may occur in the vicinity of equipment marked with the following symbol:



**Table 15: Electromagnetic Immunity, RF Portable Equipment**

For portable and mobile communication equipment. The N-595 is suitable for use in the specified electromagnetic environment. The customer and/or user of the N-595 should assure that it is used in an electromagnetic environment as described below:

| Immunity Test | IEC 60601-1-2 Test Level | Compliance Level | Electromagnetic Environment Guidance |
|---------------|--------------------------|------------------|--------------------------------------|
| Conducted RF  | 3 Vrms                   | 3 Vrms           | $distance = 1.2\sqrt{Power}$         |
| IEC 61000-4-6 | 150 kHz                  |                  | 150 kHz to 80 MHz                    |
|               | 80 MHz                   |                  |                                      |

**Note:** Field strengths from fixed transmitters, such as base stations for radio (cellular/cordless) telephones and land mobile radios, amateur radio, AM and FM radio broadcast, and TV broadcast cannot be predicted theoretically with survey accuracy. To assess the electromagnetic environment due to fixed RF transmitters, an electromagnetic site survey should be considered. If the measured field strength in the location in which the N-595 is used exceeds the applicable RF compliance level above, the N-595 should be observed to verify normal operation. If abnormal performance is observed, additional measures may be necessary, such as re-orienting or relocating the N-595.

**Note:** These guidelines may not apply in all situations. Electromagnetic propagation is affected by absorption and reflection from structures, objects, and people.

Interference may occur in the vicinity of equipment marked with the following symbol:



**Table 16: Recommended Separation Distances**

Recommended Separation Distances between Portable and Mobile RF Communications Equipment and the N-595 (IEC 60601-1-2)

| Frequency of Transmitter                           | 26 MHz to 80 MHz              | 80 MHz to 800 MHz             | 800 MHz to 2.5 GHz            |
|--|-------------------------------|-------------------------------|-------------------------------|
| Equation   | $d = 1.2\sqrt{P}$             | $d = 1.2\sqrt{P}$             | $d = 2.3\sqrt{P}$             |
| Rated Maximum Output Power of Transmitter in Watts | Separation Distance in Meters | Separation Distance in Meters | Separation Distance in Meters |
| 0.01   | 0.12                          | 0.12                          | 0.23                          |
| 0.1  | 0.38                          | 0.38                          | 0.73                          |
| 1  | 1.2                           | 1.2                           | 2.3                           |
| 10   | 3.8                           | 3.8                           | 7.3                           |
| 100  | 12                            | 12                            | 23                            |

For transmitters rated at a maximum output power not listed above, the separation distance can be estimated using the equation in the corresponding column, where P is the maximum output [power rating of the transmitter in watts (W)] according to the transmitter manufacturer.

**Note:** These guidelines may not apply in all situations. Electromagnetic propagation is affected by absorption and reflection from structures, objects, and people.

**Table 17: Cables**

| <b>Cables and<br/><i>OxiMAX</i><br/>Sensors</b>         | <b>Maximum<br/>Length</b> | <b>Complies With</b>   |
|---|---------------------------|--|
| DOC-10 pulse oximetry cable                             | 10 ft. (3 m)              | <ul style="list-style-type: none"> <li>RF emissions, CISPR 11, Class B/Group 1</li> </ul>  |
| Software download cable, RS-232 serial, 15 to 9 pin “D” | 10 ft. (3 m)              | <ul style="list-style-type: none"> <li>Harmonic emissions, IEC 61000-3-2</li> <li>Voltage fluctuations/flicker emission, IEC 61000-3-3</li> </ul>    |
| Non-terminated cable, RS-232/ Analog, 15 pin “D”        | 3.3 ft. (1 m)             | <ul style="list-style-type: none"> <li>Electrostatic discharge (ESD), IEC 61000-4-2</li> <li>Electric fast transient/burst, IEC 61000-4-4</li> </ul> |
| Oxinet hardwire cable                                   | 10 ft. (3 m)              | <ul style="list-style-type: none"> <li>Surge, IEC 61000-4-5</li> </ul>   |
| Printer cable, RS-232, 15 to 9 pin “D”                  | 3.3 ft. (1 m)             | <ul style="list-style-type: none"> <li>Conducted RF IEC 61000-4-6</li> <li>Radiated RF, IEC 61000-4-3</li> </ul>                                     |
| HP Agilent interface cable                              | 3.3 ft. (1 m)             |  |
| GE Marquette interface cable                            | 3.3 ft. (1 m)             |  |
| Datex-Ohmeda interface cable                            | 3.3 ft. (1 m)             |  |
| Oxinet® II Data Cable                                   | 10 ft. (3 m)              |  |
| HP Agilent interface cable                              | 10 ft. (3 m)              |  |

**Table 17: Cables**

| <b>Cables and<br/><i>OxiMAX</i><br/>Sensors</b> | <b>Maximum<br/>Length</b> | <b>Complies With</b>   |
|---|---------------------------|--|
| <i>OxiMAX</i><br>sensors:                       |                           | <ul style="list-style-type: none"> <li>RF emissions, CISPR 11, Class B/Group 1</li> </ul>              |
| MAX-A   | 1.5 feet (0.5 m)          |  |
| MAX-AL  | 3 feet (0.9 m)            | <ul style="list-style-type: none"> <li>Harmonic emissions, IEC 61000-3-2</li> </ul>                    |
| MAX-I   | 1.5 feet (0.5 m)          | <ul style="list-style-type: none"> <li>Voltage fluctuations/flicker emission, IEC 61000-3-3</li> </ul> |
| MAX-N   | 1.5 feet (0.5 m)          |  |
| MAX-P   | 1.5 feet (0.5 m)          | <ul style="list-style-type: none"> <li>Electrostatic discharge (ESD), IEC 61000-4-2</li> </ul>         |
| MAX-R   | 1.5 feet (0.5 m)          | <ul style="list-style-type: none"> <li>Electric fast transient/burst, IEC 61000-4-4</li> </ul>         |
|   | 1.5 feet (0.5 m)          | <ul style="list-style-type: none"> <li>Surge, IEC 61000-4-5</li> </ul>                                 |
| <i>OxiMAX</i><br><i>Oxiband</i><br>sensors:     | 3 feet (0.9 m)            | <ul style="list-style-type: none"> <li>Conducted RF IEC 61000-4-6</li> </ul>                           |
| OXI-A/N   |                           | <ul style="list-style-type: none"> <li>Radiated RF, IEC 61000-4-3</li> </ul>                           |
| OXI-P/I   |                           |  |

**Table 17: Cables**

| <b>Cables and<br/><i>OxiMAX</i><br/>Sensors</b> | <b>Maximum<br/>Length</b> | <b>Complies With</b>  |
|---|---------------------------|---|
| <i>OxiMAX</i><br><i>Durasensor</i><br>sensor    | 3 feet (0.9 m)            | <ul style="list-style-type: none"> <li>• RF emissions, CISPR 11, Class B/Group 1</li> </ul>   |
| DS-100A   |                           | <ul style="list-style-type: none"> <li>• Harmonic emissions, IEC 61000-3-2</li> <li>• Voltage fluctuations/flicker emission, IEC 61000-3-3</li> <li>• Electrostatic discharge (ESD), IEC 61000-4-2</li> <li>• Electric fast transient/burst, IEC 61000-4-4</li> <li>• Surge, IEC 61000-4-5</li> <li>• Conducted RF IEC 61000-4-6</li> <li>• Radiated RF, IEC 61000-4-3</li> </ul> |

**Table 17: Cables**

| <b>Cables and<br/><i>OxiMAX</i><br/>Sensors</b> | <b>Maximum<br/>Length</b>    | <b>Complies With</b>   |
|---|------------------------------|--|
| <i>OxiMAX</i><br><i>OxiCliq</i><br>sensors:     | OC-3 cable<br>3 feet (0.9 m) | <ul style="list-style-type: none"> <li>• RF emissions, CISPR 11, Class B/Group 1</li> <li>• Harmonic emissions, IEC 61000-3-2</li> <li>• Voltage fluctuations/flicker emission, IEC 61000-3-3</li> </ul>   |
| P   |                              |  |
| N   |                              |  |
| I   |                              |  |
| A   |                              |  |
| <i>OxiMAX</i><br><i>Dura-Y</i><br>sensors:      | 4 feet (1.2 m)               | <ul style="list-style-type: none"> <li>• Electrostatic discharge (ESD), IEC 61000-4-2</li> <li>• Electric fast transient/burst, IEC 61000-4-4</li> <li>• Surge, IEC 61000-4-5</li> <li>• Conducted RF IEC 61000-4-6</li> <li>• Radiated RF, IEC 61000-4-3</li> </ul> |
| D-YS  |                              |  |
| D-YSE   |                              |  |
| D-YSPD  |                              |  |





# *Index*

---

## **A**

AC Power Indicator 12  
Adult  
    Default Settings 140  
Adult-Pediatric Patients 42  
Alarm Limit Display 44  
Alarm Off 88  
Alarm Silence 88  
Alarm Silence Duration Display 38  
Alarm Silence Indicator 12  
Alarm Volume display 36  
Altitude 149, 150  
Analog Voltage Outputs 97  
Anemia 112  
AO 88  
Artifact 13  
AS 88  
ASCII Mode Printout 82

---

## **B**

Backlight 34  
Basket  
    Utility 109  
Baud Rate  
    Set 93  
Biocompatibility Testing 103  
Blip Display 11  
Blip View 35

---

## **C**

Cables 162  
Calculated Saturation 145  
Calibration 129  
Carrying Case  
    Soft-Sided 110

Cautions 2  
Cleaning 130  
Clock 38  
Clock Settings Lost 118, 120  
Confirmation Tone 14  
Connecting an OXIMAX Sensor 19  
Connecting the N-595 to AC Power 17  
Contrast 34  
Controls 9  
    Adjust Down 10  
    Adjust Up 10  
    Alarm Silence 9  
    Contrast 10  
    Power On/Off 9

---

## **D**

Dashes 33  
Data In Sensor 120  
Data Port  
    Connecting to 91  
    Pin Layout 93  
    Pinouts 92  
Data Port Setup 93  
DATA TYPE  
    EVENT/SPO2 120  
DATA TYPE EVENT/SPO2+BPM 120  
Date 38  
Date and Time 37  
Decimal Points 11  
Default Settings  
    Adult 140  
    Factory 139  
    Neonate 139  
Defaults Lost 118, 121  
Delete Trends? 121  
Deutsch 48  
Disabling Audio Alarms 39

Disinfecting 130

Display

    %SpO<sub>2</sub> 12

    Pulse Amplitude 12

    Pulse Rate 12

Display Language

    Selecting 48

Dual Trend Data Display 58

Dutch 48

Dysfunctional Hemoglobins 112

---

## E

Electromagnetic Emissions 155

Electromagnetic Interference 126

Electrostatic Immunity 159

English 48

Error Codes 117

Error Messages 119

Espanol 48

---

## F

Factory Default Settings 139

Fast Mode 47

Fast Response Mode Indicator 13

Fractional Saturation 144

Francais 48

French 48

Front Panel Buttons 7

Front Panel Buttons and Symbols 7

Functional Saturation 144

---

## G

GCX Mounting Plate 105

German 48

Graph Mode Printout 83

Graphical Sensor Event Record Data 71

---

## H

Histogram Trend Data Display 60

Horizontal Wall Mount 107

Hospital Type Environments 5

---

## I

In-Sensor Tabular History Data 76

Italian 48

Italiano 48

---

## L

LB 88

LM 88

Loss of Pulse 88

Loss of Pulse w/ Motion 88

Low Battery 88, 118, 121

Low Battery Indicator 12, 22

LP 88

---

## M

Manufacturer's Declaration 155

Measured Saturation 145

MO 88

Monitor

    Accuracy and Motion Tolerance 147

    Performance Considerations 111

    Returning 129

Monitor Displays Dashes 33

Monitor Trend Data 53

Motion Artifact Indicator 12

---

## N

Nederlands 48

Neonatal Patients 42

Neonate

    Default Settings 139

---

---

Neonate Alarm Limits Indicator 13  
Normal Mode 47  
Nurse Call  
    Relay Contacts 97  
    RS-232 Polarity 96  
    Using 95

---

## O

Operating  
    Relative Humidity 150  
    Temperature 149  
Operating Status 88  
Operating the N-595 on Battery Power 21  
Optional Accessories 103  
OXIMAX Technology 145  
Oximetry Overview 143

---

## P

Parameter Ranges 27  
Patient Motion 88  
Performance Considerations  
    Pulse Oximeter 111  
    Sensor 113  
Performance Verification 111  
PH 88  
PL 88  
Pleth Display 10  
Port 48  
Portuguese 48  
Power-On Self-Test(POST) 30  
Printing  
    Protocol 79  
Printing Trend Information 79  
Protocol  
    Set 93  
PS 88  
Pulse Amplitude Trend Data Display 61  
Pulse Oximeter  
    Measurement Range 147

Pulse Rate High Limit Alarm 88  
Pulse Rate Low Limit Alarm 88  
Pulse Rate Trend Display 59  
Pulse Search 88  
Pulse Search Indicator 13

---

## R

Reading Trends 121  
Real-Time Data 83  
Rear Panel Components 8  
Recommended Separation Distances 161  
Response Mode 86  
Response mode 47  
Returning the Monitor 129  
Roll Stand 108

---

## S

Safety Checks 130  
SatSeconds  
    Alarm Management 135  
    Describing 135  
    Display 137  
    Safety Net 137  
SatSeconds Indicator 13  
Saturation  
    Calculated 145  
    Fractional 144  
    Functional 144  
    Measured 145  
Saturation High Limit Alarm 89  
Saturation Low Limit Alarm 89  
Screen Contrast 34  
Scroll, Trend Data 54  
SD 89  
Searching for a Valid Pulse. 32  
Selecting a Sensor 101  
Selecting the Trend Data Display Scale 55  
Sensor  
    Performance Considerations 113

Sensor Disconnect 89  
Sensor Disconnected 121  
Sensor Event History Data 73  
Sensor Event Record 66  
Sensor Event Record Available 69  
Sensor Event Record Not Available 70  
Sensor Message Enable/Disable 127  
Sensor Message Setup 127  
Sensor Off 89  
Sensor Type 122  
Setting SatSeconds Alarm Limit 46  
Settings Lost 118  
SH 89  
SL 89  
SO 89  
Soft-Sided Carrying Case 110  
Software Version 30  
Spanish 48  
Specifications 147  
    Battery 148  
    Compliance 152  
    Electrical 148  
    Electrical,Instrument 148  
    Environmental 149  
    Performance 147  
    Physical 151  
SpO2 Trend Display 59  
Stand  
    Roll 108  
Storage  
    Relative Humidity 150  
    Temperature 150  
Swedish 48  
Symbols 8  
    Data Interface 9  
    Data of Manufacture 9  
    Equipotential Terminal 9  
    Fuse Replacement 8  
    See Instructions for Use 8  
    Type BF Applied Part 9

---

## T

Technical Assistance 126  
Tone  
    Alarm Silence Reminder 14  
    Confirmation Tone 14  
    High Priority Alarm 14  
    Invalid Button Press 14  
    Low Priority Alarm 14  
    Medium Priority Alarm 14  
    Power-On Self-Test Pass 14  
    Pulse Beep 14  
    Valid Button Press 14  
    Volume Setting Tone 14  
Transport  
    Relative Humidity 150  
    Temperature 150  
Trend Data  
    Operation 55  
Trend Data Display  
    Reading 57  
Trend Display  
    Dual Trend 58  
    Histogram 60  
    Pulse Amplitude 61  
    Pulse Rate 59  
    Reading the 57  
    Scale 55  
    SpO2 59  
Trend Scale 55  
Troubleshooting  
    Help 122  
Turning On the Monitor 29

---

## U

Utility Basket 109

---

## V

Verification

Performance 111  
Vertical Wall Mount 106

Horizontal 107  
Vertical 106  
Warning 1

---

**W**

Wall Mount





**tyco**  

---

*Healthcare*

**Nellcor**

Tyco Healthcare Group LP  
Nellcor Puritan Bennett Division  
4280 Hacienda Drive  
Pleasanton, CA 94588 U.S.A.  
Telephone Toll Free 1.800.635.5267

Authorized Representative  
Tyco Healthcare UK LTD  
154 Fareham Road  
Gosport PO13 0AS, U.K.

**Rx ONLY**

**CE**  
**0123**